



Innovative **Technology**
for a **Connected** World

Technology Advancements in Board Level Shields for EMI Mitigation

Not Your Daddy's Metal Can

Gray Fenical

iNARTE EMC and ESD Engineer



www.lairdtech.com

AFCem

APPROACH

- Fixing the CAUSE of the problem is **always** better and less expensive than fixing the SYMPTOM

A Board Level Shield (BLS) is the most efficient and least expensive shielding solution and is used closest to the source of the problem

© 1988 Henry W. Ott

Cost of Shielding

There is a cost hierarchy to shielding which makes it commercially very important to consider shielding early in the design process. Shields may be fitted around:

(Relative Pricing – Not True Values)

Individual ICs	\$0.25
Segregated areas of PCB circuitry	\$1.00
Whole PCBs	\$10.00
Sub-assemblies and modules	\$15.00
Complete products	\$100
Assemblies (e.g. industrial control and instrumentation cubicles)	\$1,000
Rooms	\$10,000
Buildings	\$100,000

PC Board Shielding

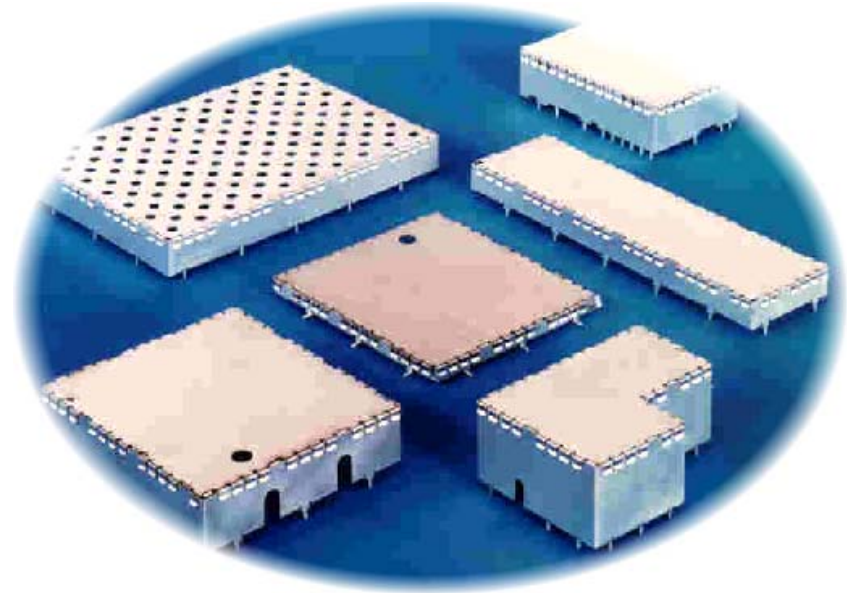

Original Product Overview Board Level Shielding

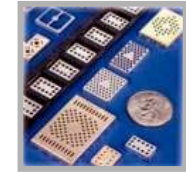

Increasing Cost

Single Piece

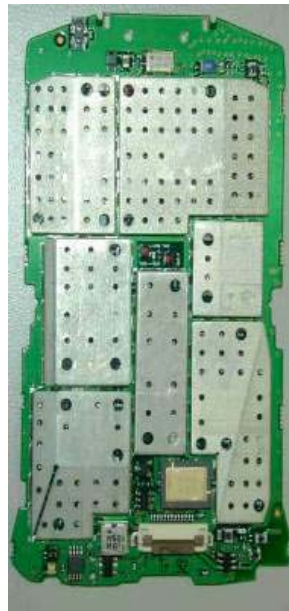

EZ Peel™

Top peeled for access



After repair



Un-Assembled

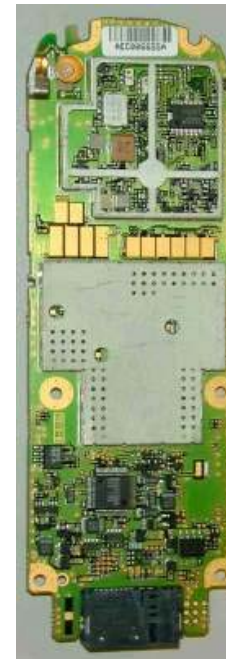

Pre-Assembled

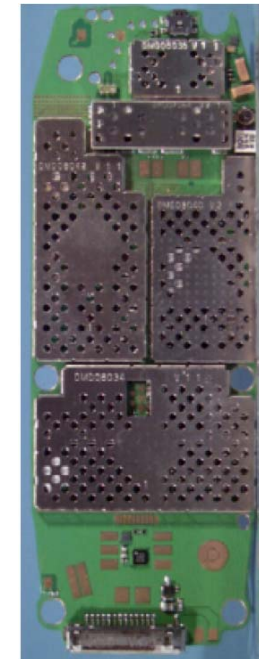

Increasing Access to Components for Repair

Materials used for BLS

- **Tin Plated Cold Rolled Steel (CRS) – Cheapest option**
- **Nickel Silver (Cu Ni Zn)**
- **Stainless Steel**
- **Tin Plated Phosphorous Bronze**

- **ALL materials are RoHs compliant**

One Piece Shield

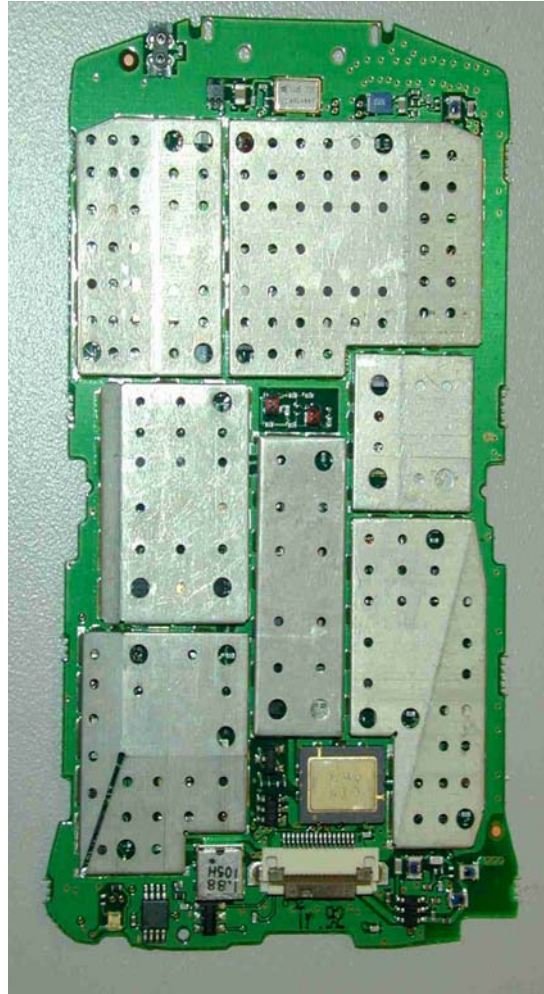

- **Holes**
 - Max. hole size is 3 mm [for RF reasons, $3\text{mm} \rightarrow 100\text{ GHz} / 20 = 5\text{ GHz}$]
 - Min. hole size is 1 mm
 - Holes improve heat dissipation and allow access to test points.
 - Number of holes impacts tooling price.
- **Critical Dimensions**
 - Length, Width
 - Height
 - Co-planarity

2 Piece Shield: Pre-Assembled

- Cover is assembled onto frame at LT, placed in carrier tape and shipped to customer.
- Pick-up area not needed.
- 1.2 mm minimum assembled height is possible.
- Automation tooling requires about a million parts to be cost effective. We have some new assembly methods reducing this to about 250,000.

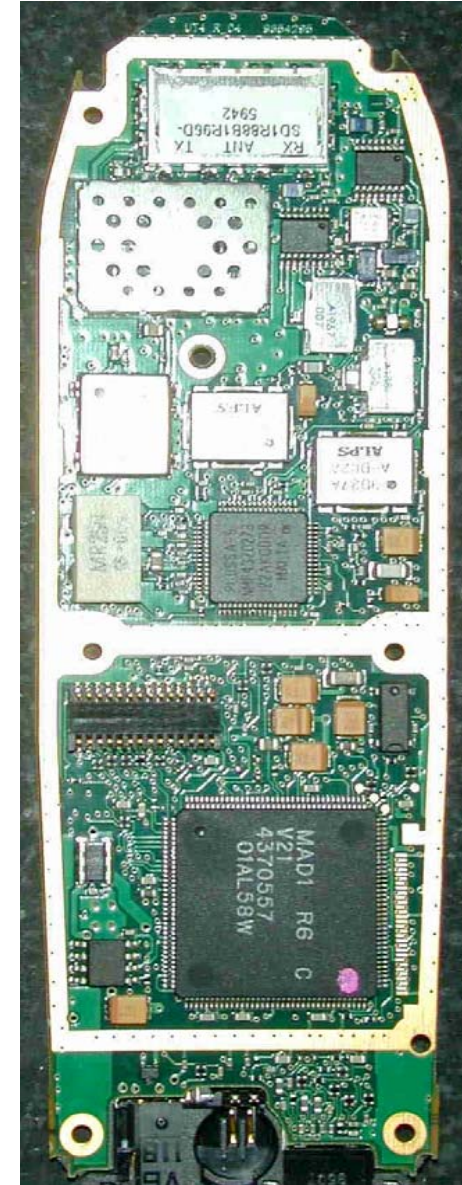

2 Piece Shield: Shield Frame

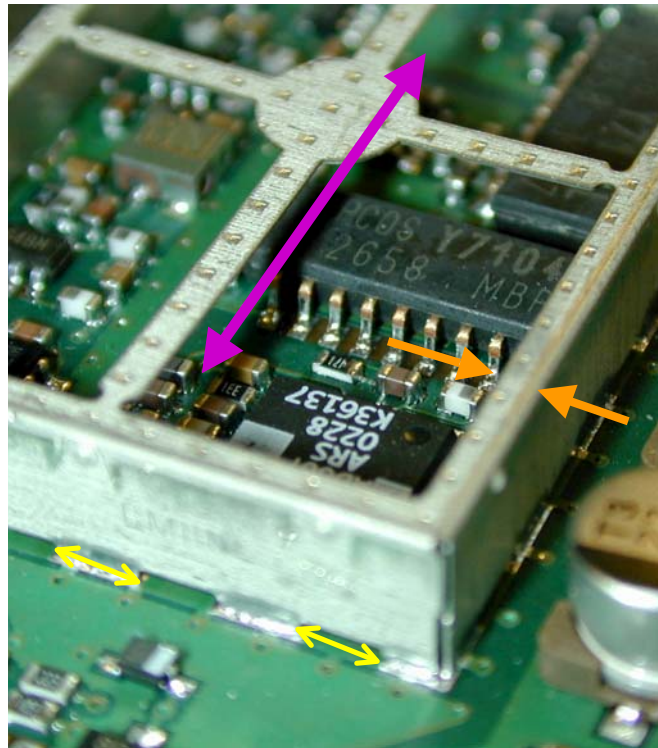

- Castellations
 - 3 mm x 0.5 mm
- Cross members are desired for support on lengths > 30 mm.
- Min. width of lip 1.00 mm. [prefer 1.50 mm].
- Lip can be 0.80 mm over distances less than 5 mm.

2 Piece Shield: Shield Assembly

- Frame is placed automatically and cover is hand placed (typically).
- Minimum total height [currently in production] is 1.2 mm.
- Typically allow 0.5 mm between bottom edge of cover and PCB surface.

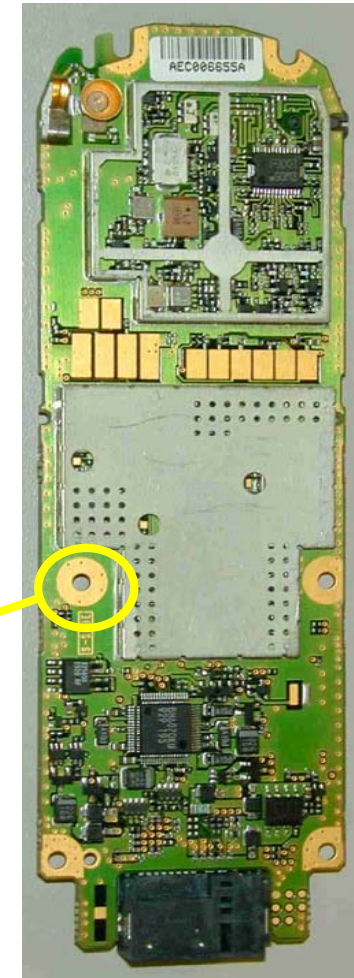
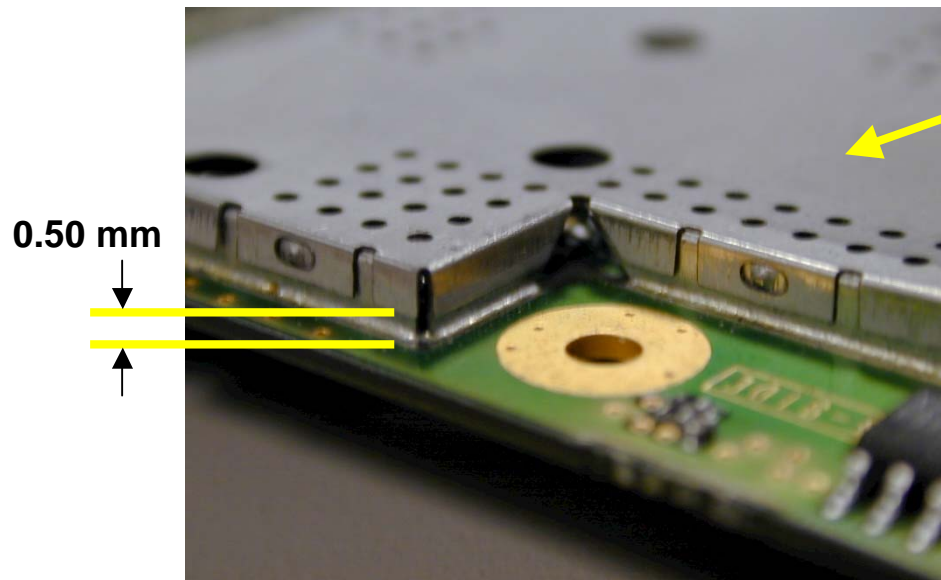

D-Snap in cross section

Difficult Access

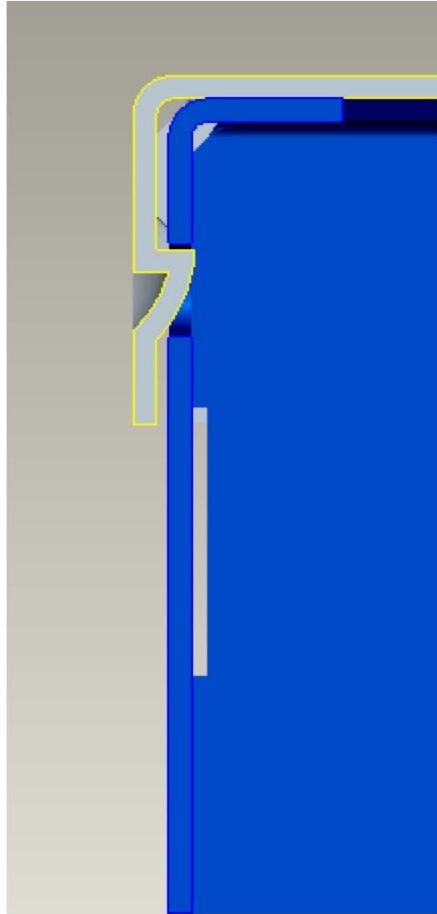

Removable

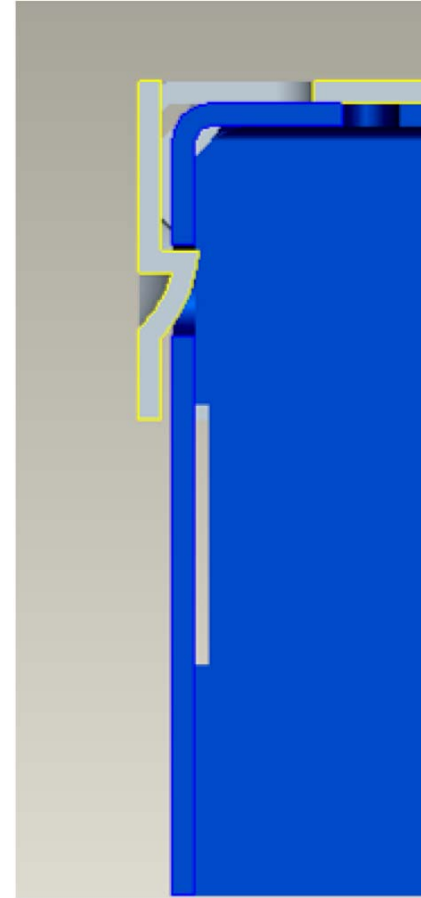

- Two options are available depending on access requirements.

2 Piece Shield: Shield Cover

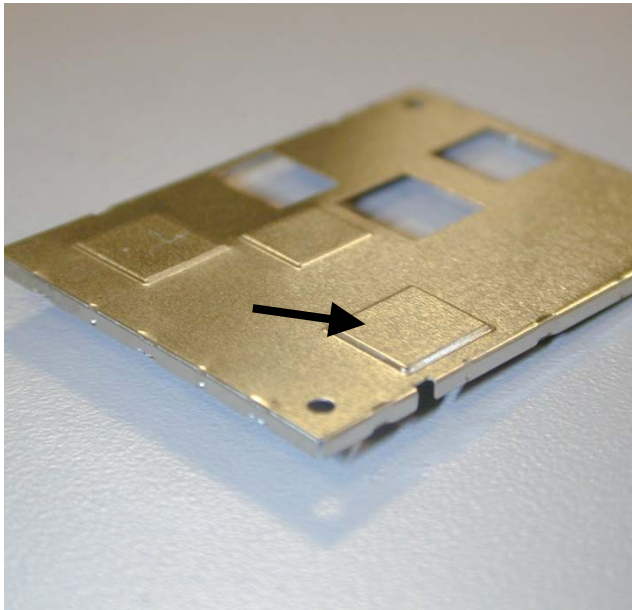

- Snaps into frame with dimple locking into slot.
- Typically we want any draw height to be less than 3 times material thickness.
- Dimples can be on cover [preferred] or frame. Dimple on the cover allows lower minimum height. We have a 1.2 mm total assembled height in production.

2 Piece Shield: Pick-Up Area

- Used for automatic placement on PCB.
- 6 mm diameter is preferred (We can go smaller, but this can impact package speeds and cost).
- Center of part is preferred.

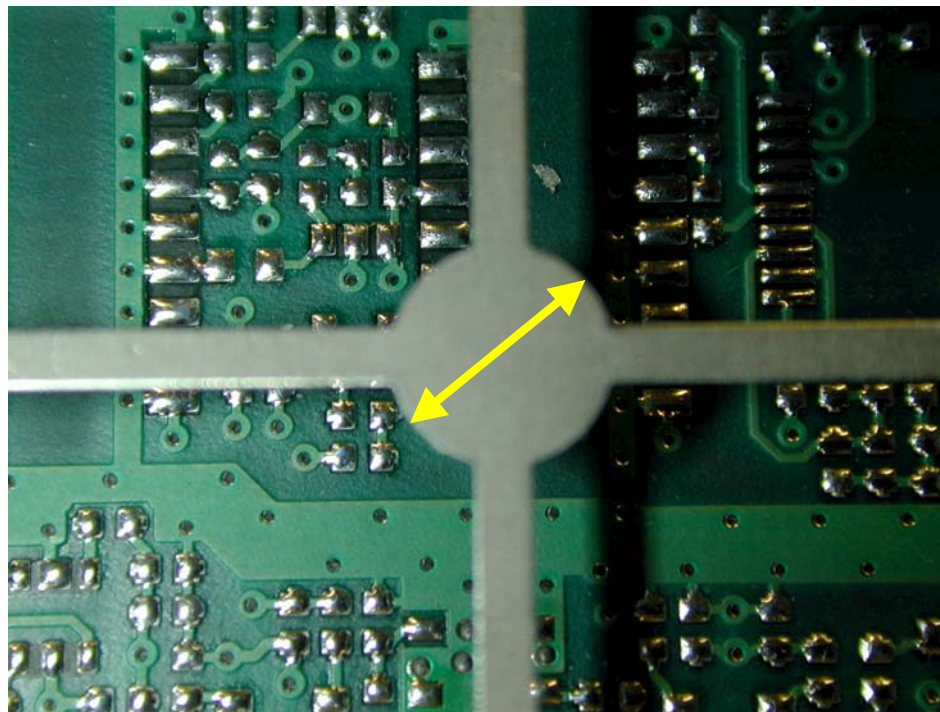

EZ Removable Pick & Place Bridge

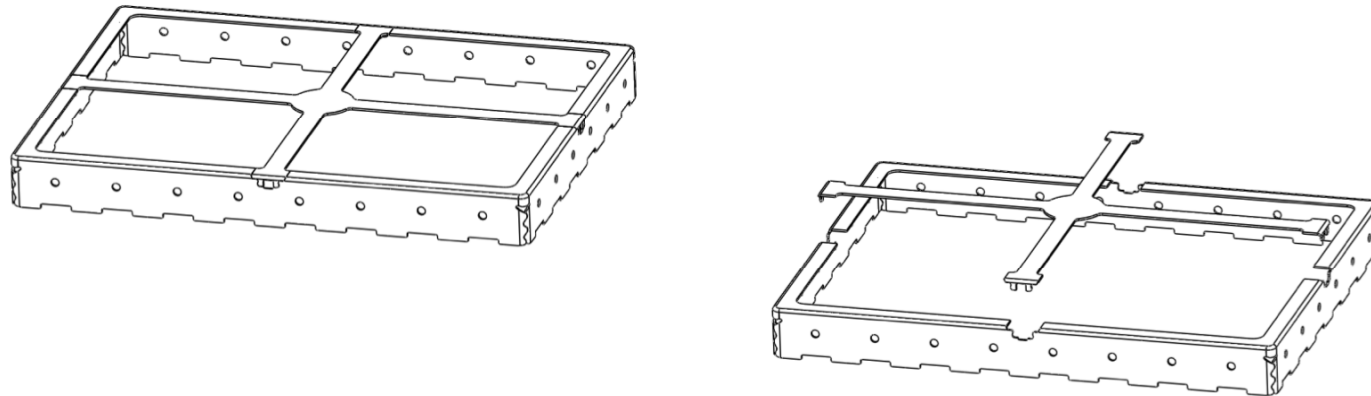

ReCover attachment mechanism applied to the pick and place bridge of a BLS frame to allow for easy, toolless, removal of the bridge after the frame is soldered to the PCB. Ease of removal along with reliable and consistent removal force will allow for automated removal.

BLS Frame with Cover

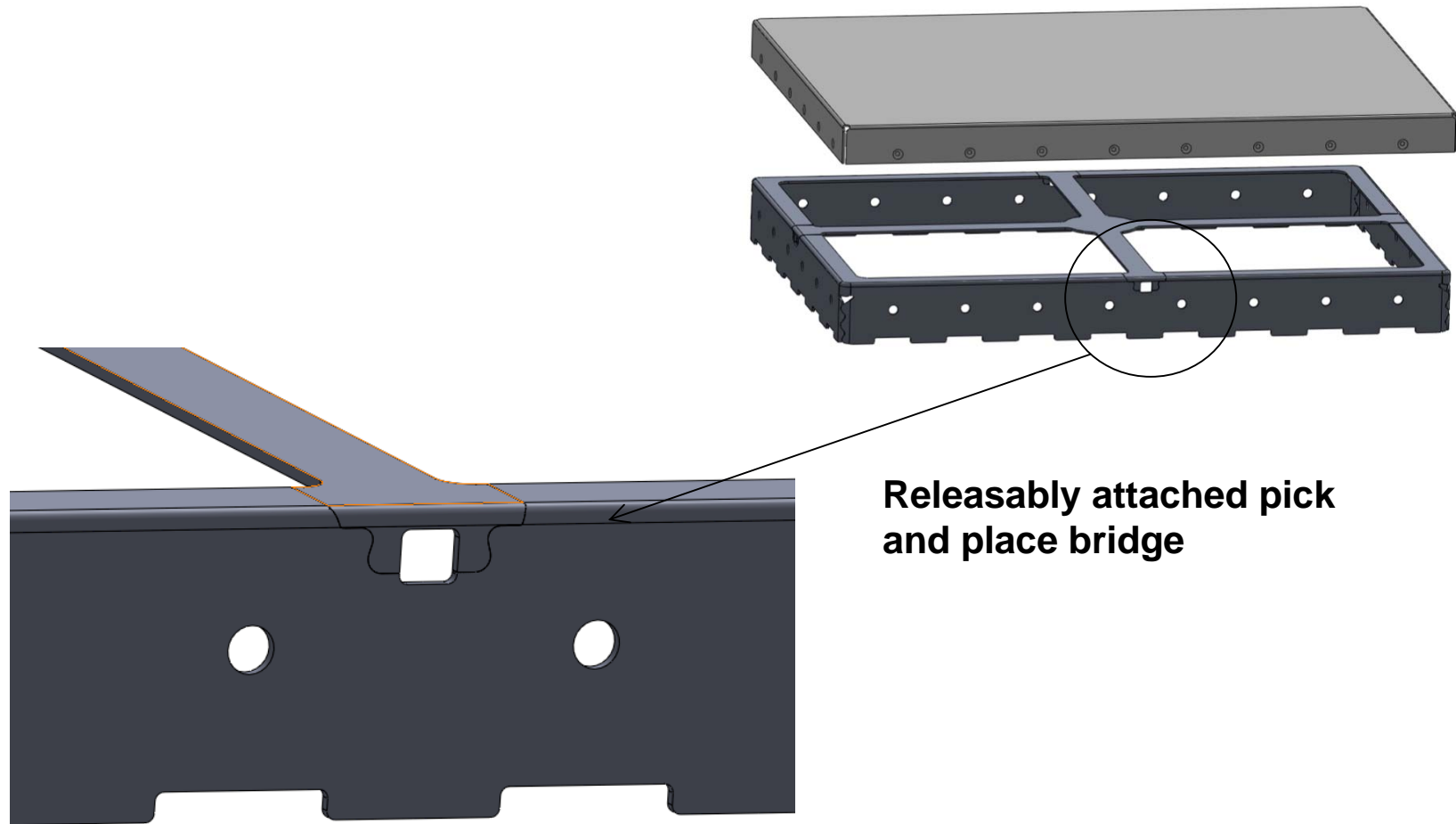

**Releasably attached pick
and place bridge**

Low Z Height Option

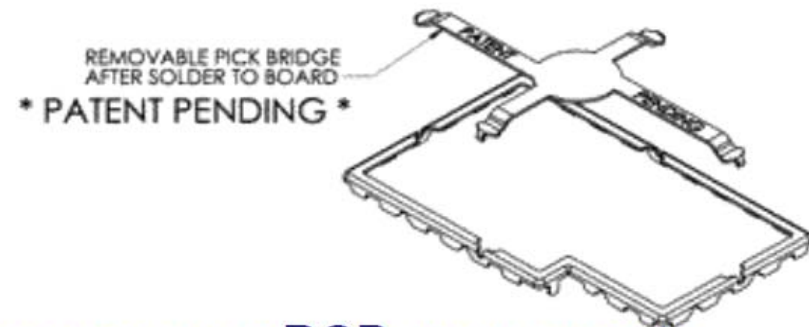

- Offset / Raised Bridge allows for clearance over PCB components during PCB placement and reflow.
- Allows for overall reduction in final Z height since the frame height, after bridge removal, no longer needs to account for the component heights prior to reflow. (Difference between PCB component placement height before and after solder reflow.)
- Additional Parameters (in addition to basic Re-Movable bridge design)
 - Minimum height: 1.0 mm.
 - Offset Distance: 0.6 mm
 - Flange width: 1.0 mm
 - Bridge Requires removal after reflow. (Non-raised bridge does not.)

Low Z Height Application

Typical BLS with Pickup Bridge

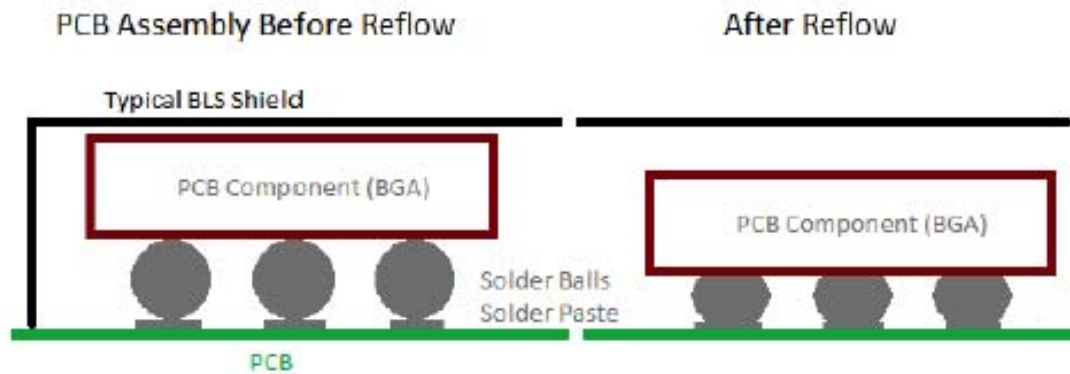

Low Z Height, Removable Raised Pickup Bridge

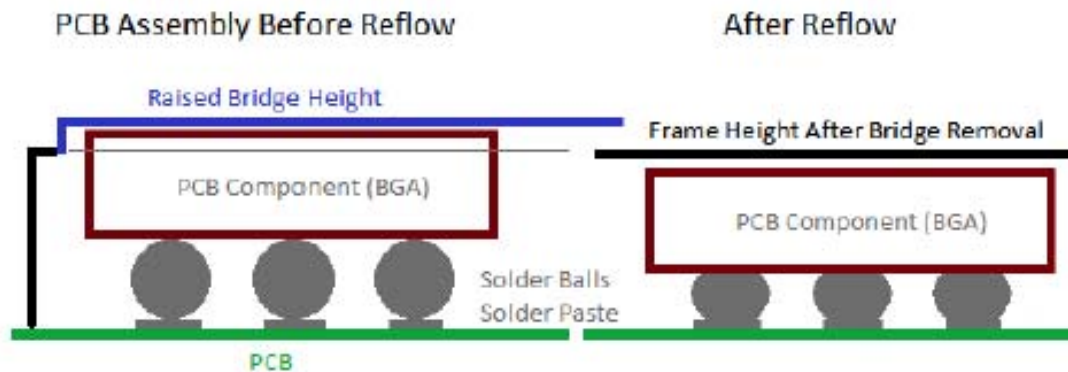

Advantages:

- Lower installed height of PCB / BLS assembly. (Solder Paste / Solder Ball settling height.)
- Greater clearance of BLS pickup bridge to PCB components
- Easy, tool less or automated removal of pickup bridge.

Example of EZ Peel[®]

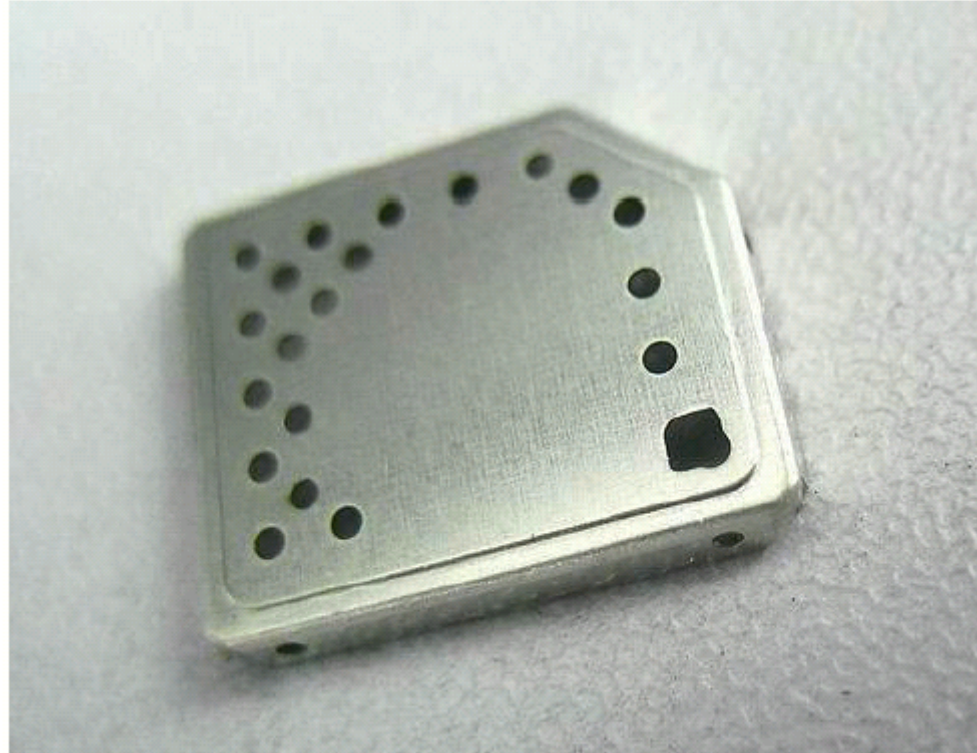

Multi-Compartment BLS

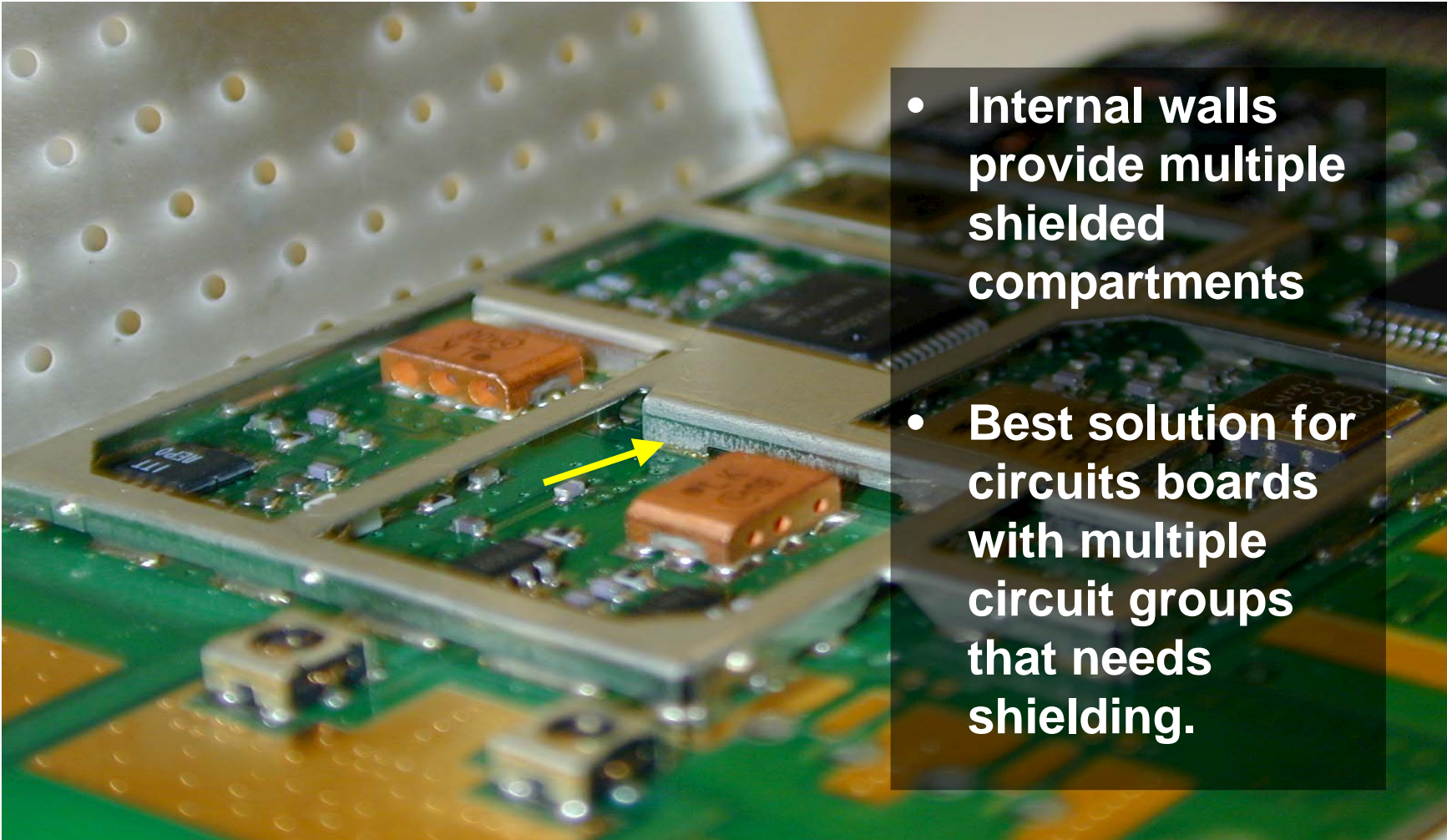

- Internal walls provide multiple shielded compartments
- Best solution for circuits boards with multiple circuit groups that needs shielding.

EZ Peel Removable Lid PC Board Shielding

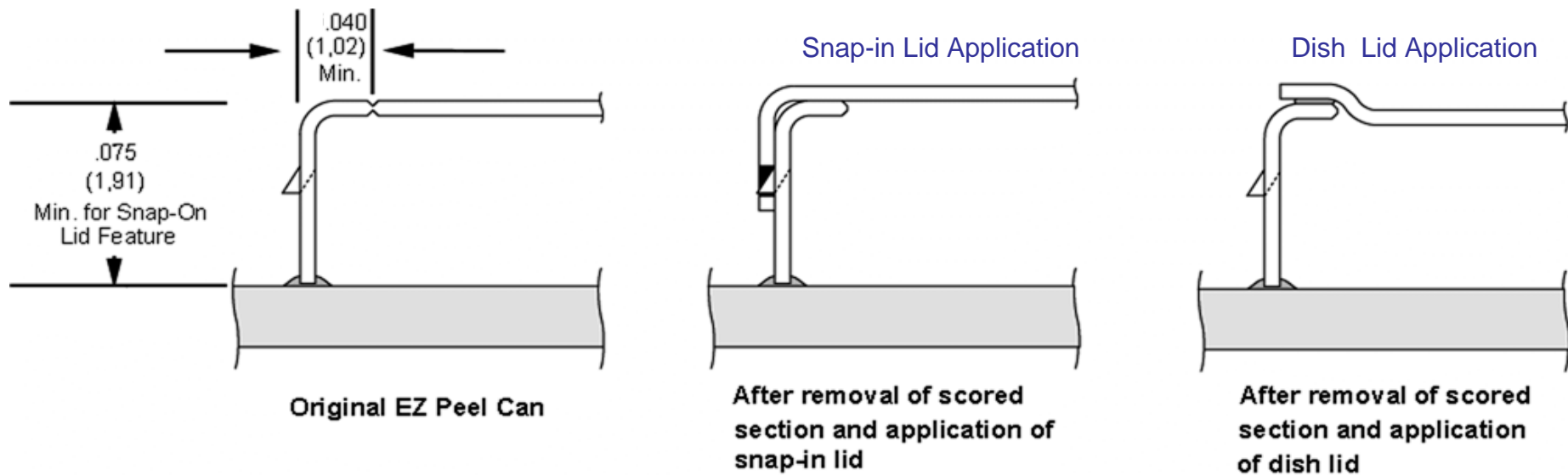

Drawn Cans

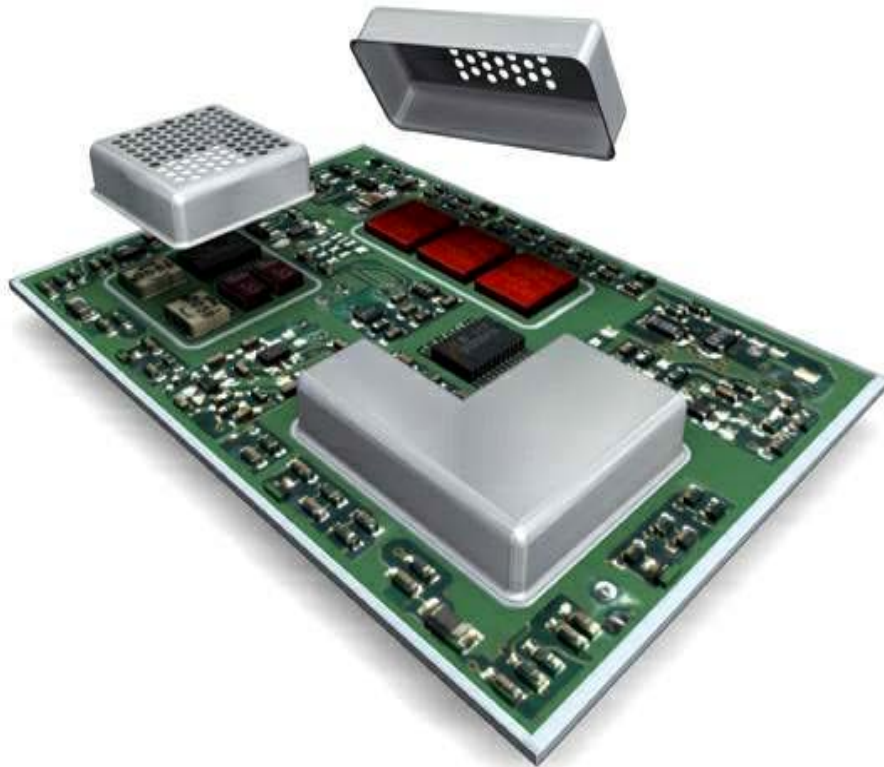

Developed as a next generation BLS product.

- The product addresses a way to increase S.E. at the board level due to fewer and smaller apertures such as the corners.**

Ruble Corner Detail

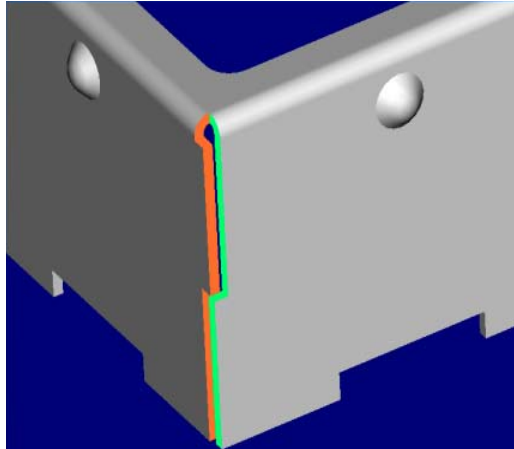

Concept

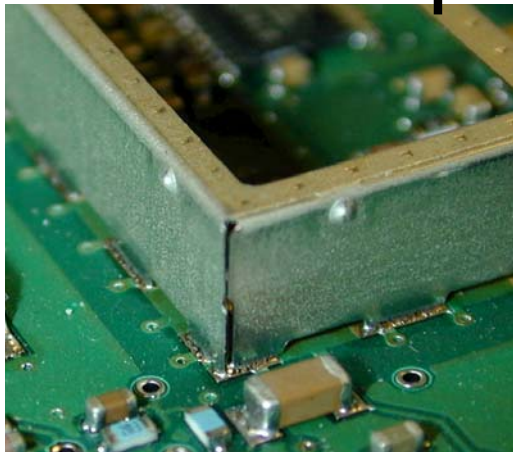

Actual

- An LT innovation!
- Reduced corner seam, improves shielding effectiveness and reduces nesting during packaging.
- Two or more tabs used depending on height and minimum gap.
- Used on corners over 2.50 mm.
- Available on frames and single piece shields.

Design Comments – Rigid Corner

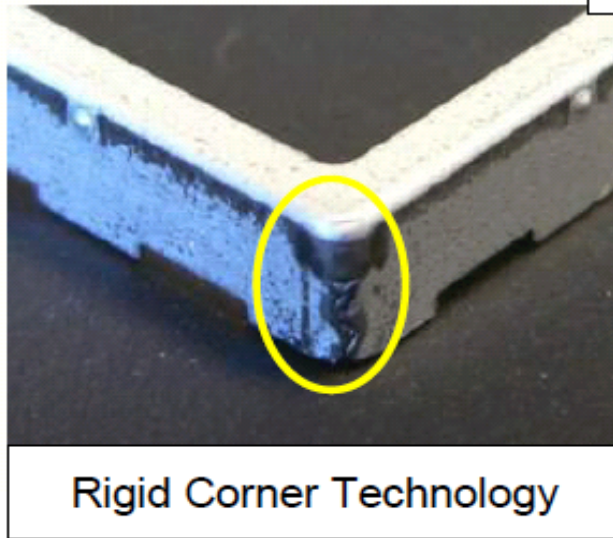
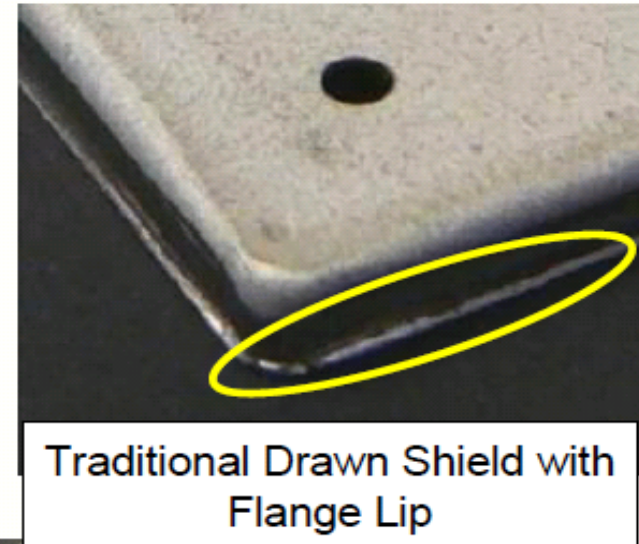
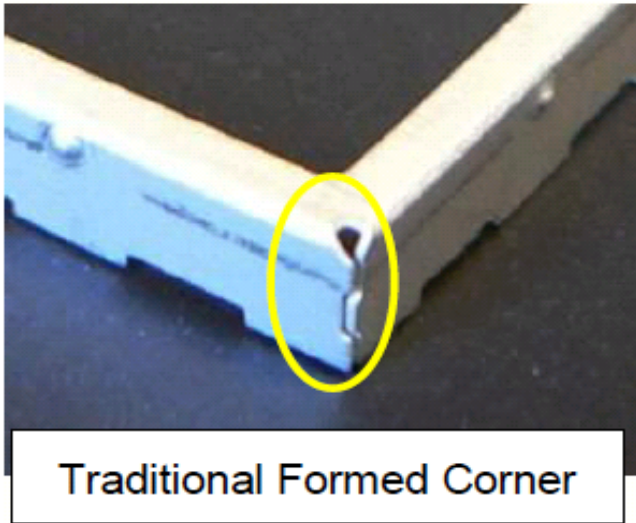

PATENT PENDING



Innovative Technology
for a Connected World

Rigid Corner Board-Level Shield

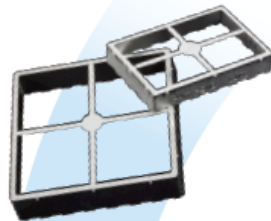

RIGID CORNER BOARD-LEVEL SHIELD

The rigid corner board-level shield incorporates a corner design that optimizes component rigidity for increased part and printed circuit board (PCB) firmness. As PCB designers are increasingly using thinner substrates, a rigid frame reinforces the assembly, thereby improving overall ruggedness and performance. The shield has improved solder joint reliability and resistance to solder joint fracture, especially in drop testing performance with thin PCBs.

The rigid corner shield is stronger and more robust than traditional drawn shields, which results in coplanarity improvement of the solder castellations. The shield can tolerate more deflection (i.e., more handling) without plastic deformation. Elimination of drawn flange reduces the space needed on the PCB for shielding trace width by potentially ~0.3 mm, allowing for the shield to be more closely placed on the PCB. Elimination of draft allows for more undershield space and improved component clearance.

The partially drawn corner is located near the top portion the shield, resulting in improved torsional rigidity with no drawn lip and no draft. For parts over 2 mm, the corner is both drawn and formed with an interlocking multi-radius corner, which provides superior EMI shielding effectiveness. The interlocking corner can be meshed and closed in during the forming and drawing process for additional improved rigidity for parts taller than 2 mm. For parts under 2 mm, the entire corner is drawn without an interlocking corner.

FEATURES

- Corner openings are reduced, improving shielding performance
- Partially drawn corner located near the top portion of the corner combined with 90° straight forming of wall sections for improved torsional rigidity.
- U.S. Patent No. 7,488,902

MARKETS

- Computing
- Telecommunications
- Data Transfer and Information Technology
- Automotive
- Consumer Electronics
- Aerospace / Defense
- Medical
- Portability
- Industrial & Instrumentation
- Public Utilities

BENEFITS

- Shield can tolerate more deflection (handling) without plastic deformation
- Shield provides increased stiffness to the PCB
- Tooling costs are not impacted
- Elimination of draft allows for more undershield space and component clearance

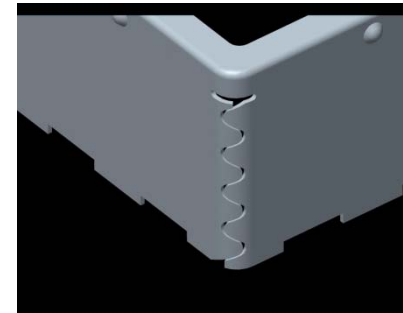

Rigid Corner Board-Level Shield

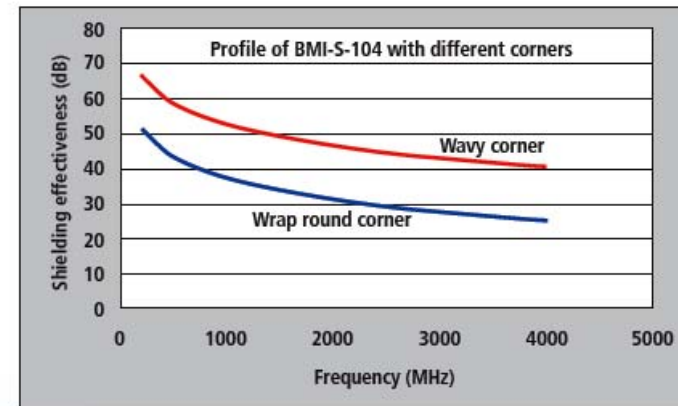

$$SE_{dB} \approx 100 - 20 \log(wfMH) + 20 \log[1 + \ln(w/h)] + 30(t/w) \quad | \quad w < \lambda/2$$

where w is length of slot and w>h and w>>t; λ is wavelength in meter; fMH is frequency in MHz.

The longest dimension of the aperture limits or dominates the BLS shielding effectiveness.



Innovative Technology
for a Connected World

Shielding Effectiveness Test

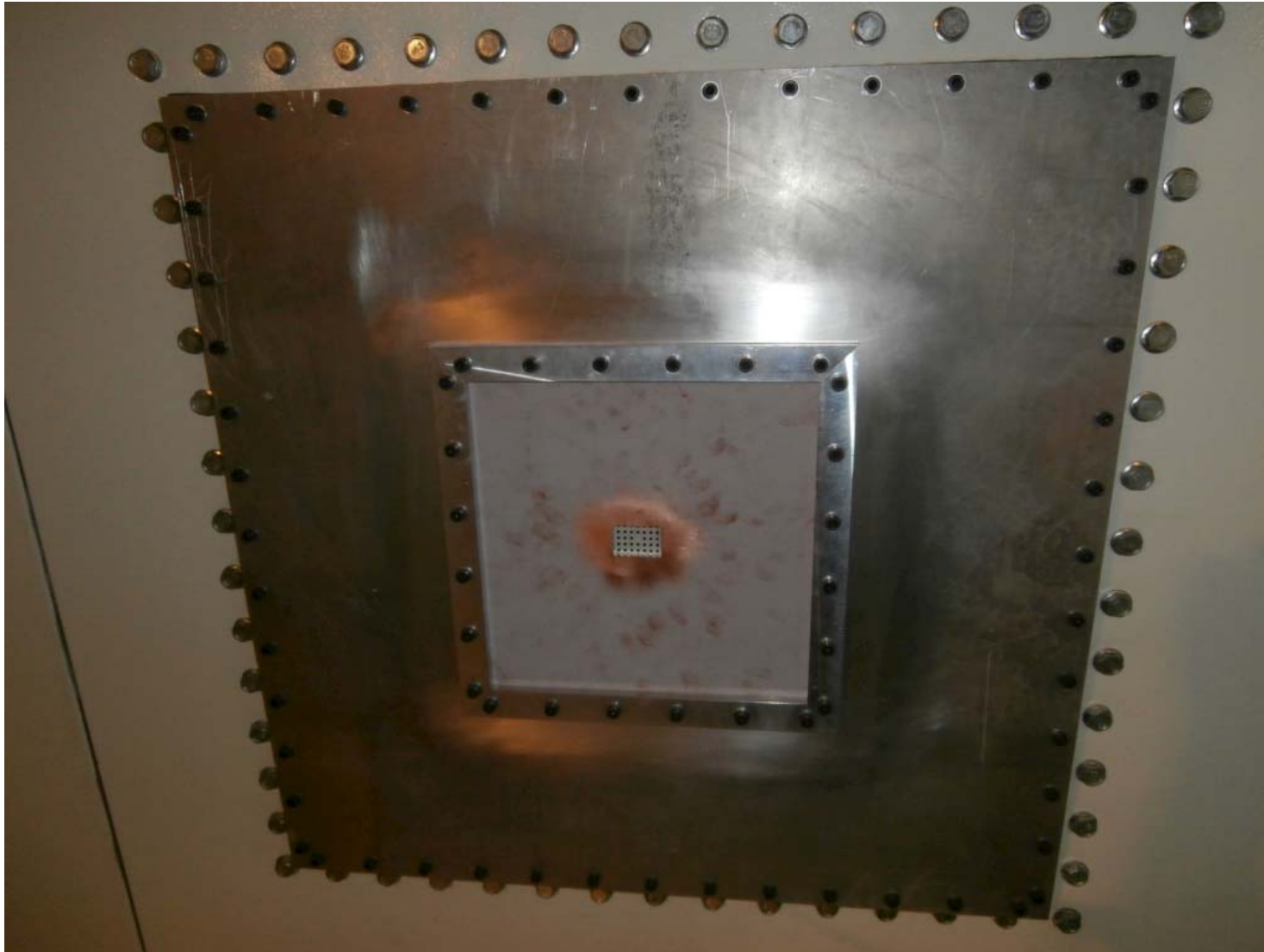

Shielding Effectiveness

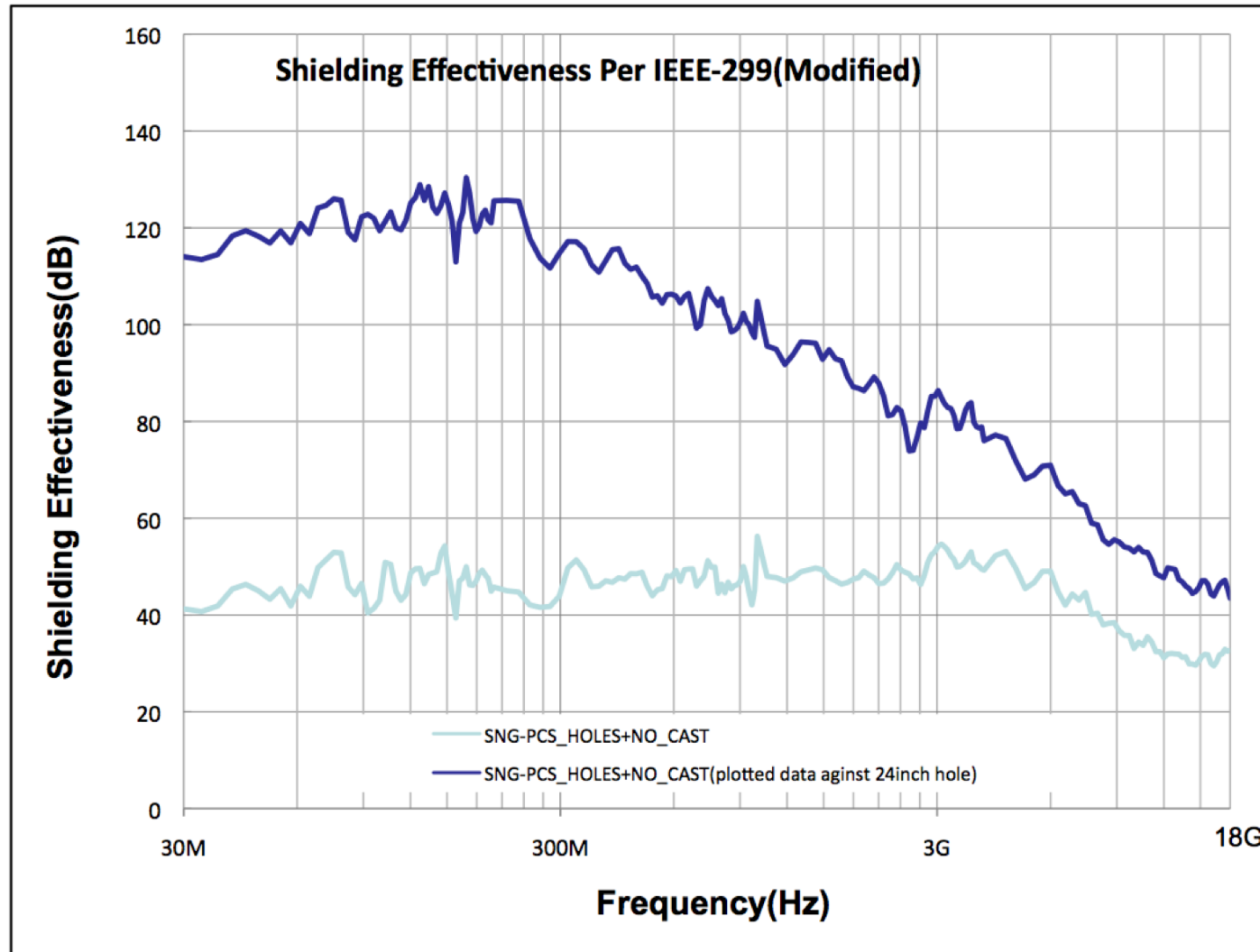

Shielding Effectiveness

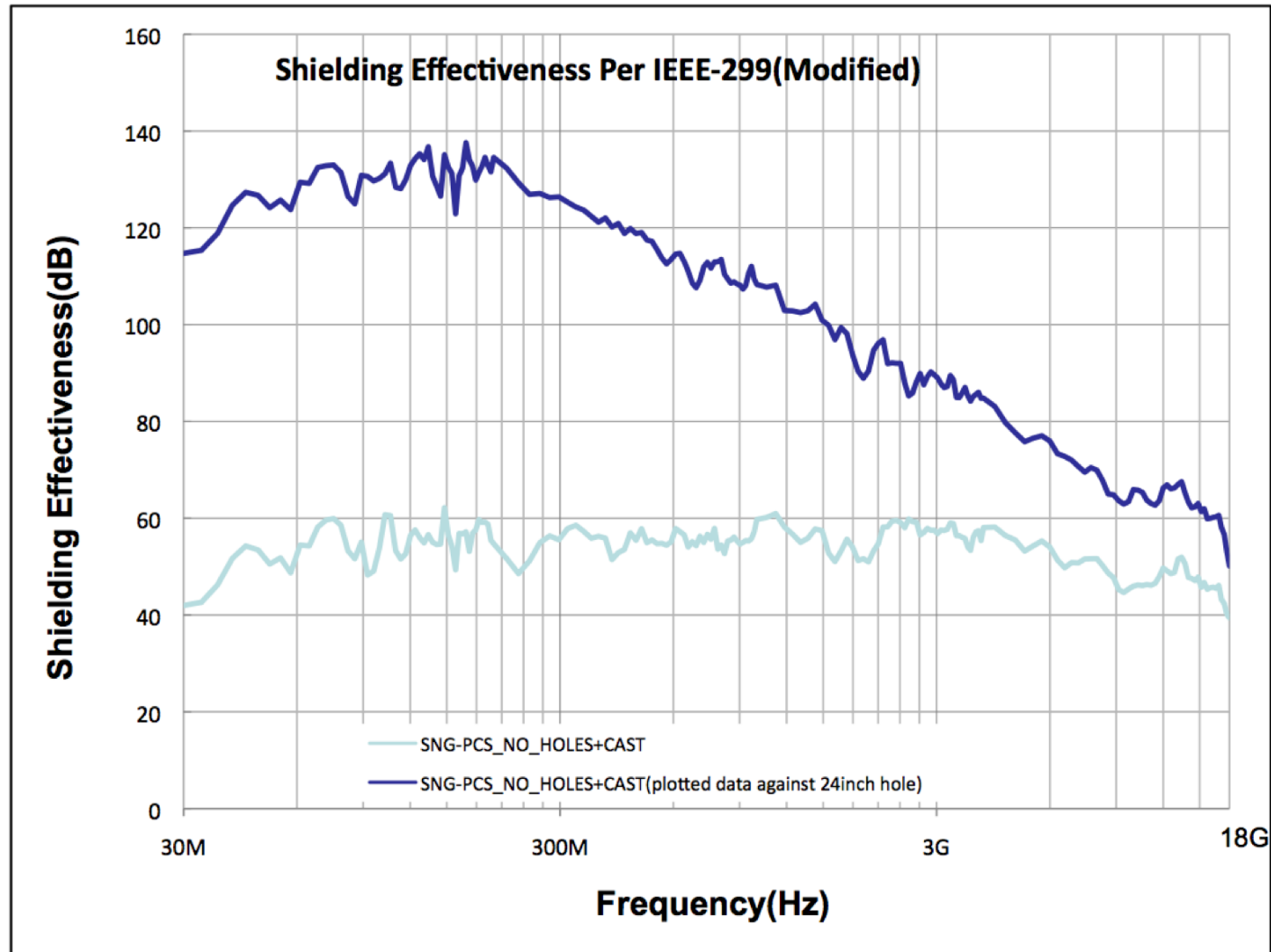

Shielding Effectiveness

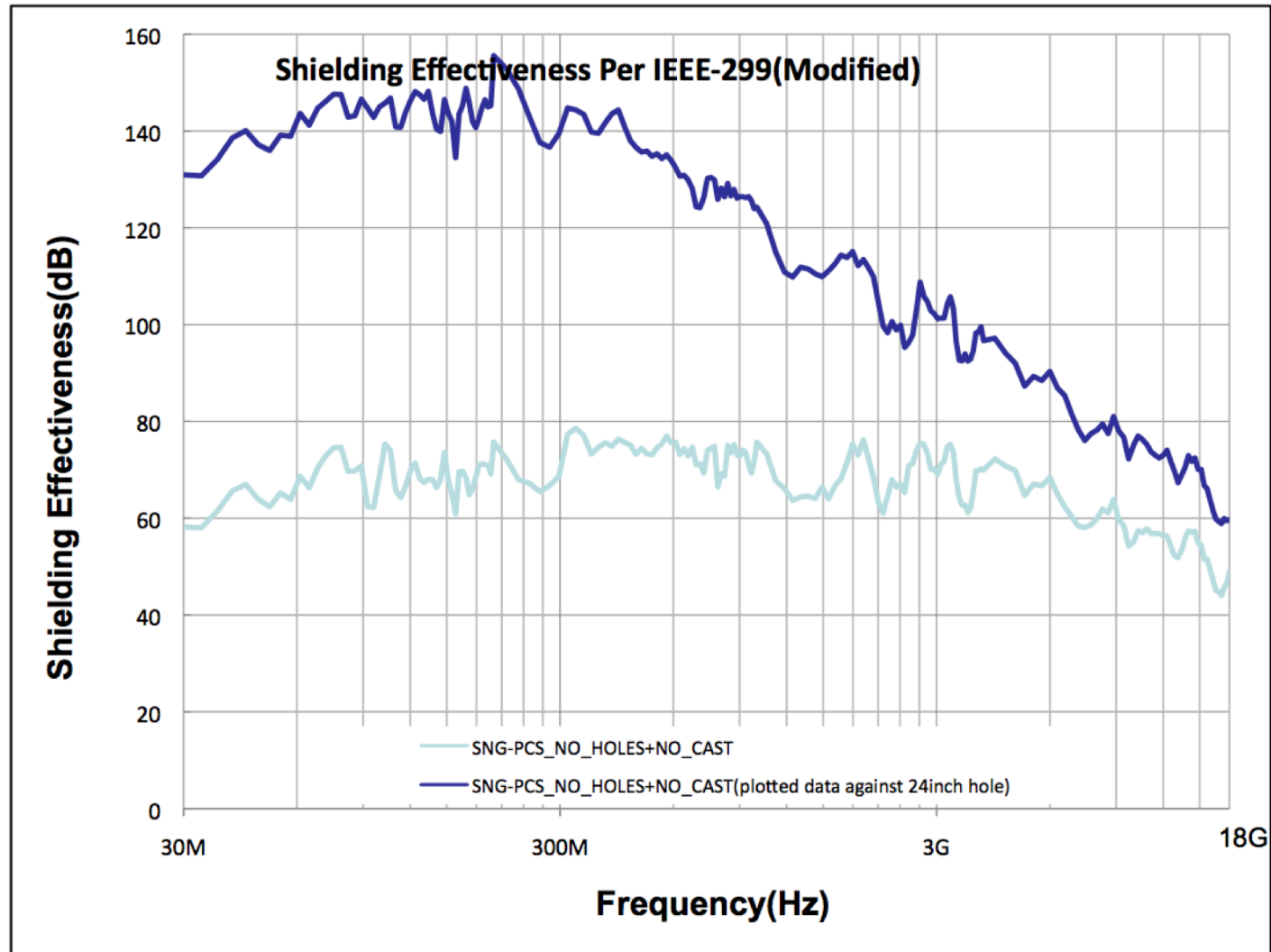



Innovative **Technology**
for a **Connected** World

New Generation of Board Level Shields



www.lairdtech.com

ReCovr – Corner and retention detail

- Side walls are tied together in the corners via Laird Technologies' Rigid Corner feature.
- In the side wall, the combination of blanking and shearing patterns, result in a snap retention feature which allows for removal and subsequent re-assembly of the top cover.
- When removed, the vertical sides remain allowing for maximum access to board components for rework requirements.



New BLS Product Discussion: Single Piece Removable Replaceable [Re-Cover] Board Level Shielding



Shield as manufactured
and installed



Shield walls remaining
attached w/ Shield
removed



Shield aligned for snap-in

PATENT PENDING

Details on side profile cuts to create snap in feature.

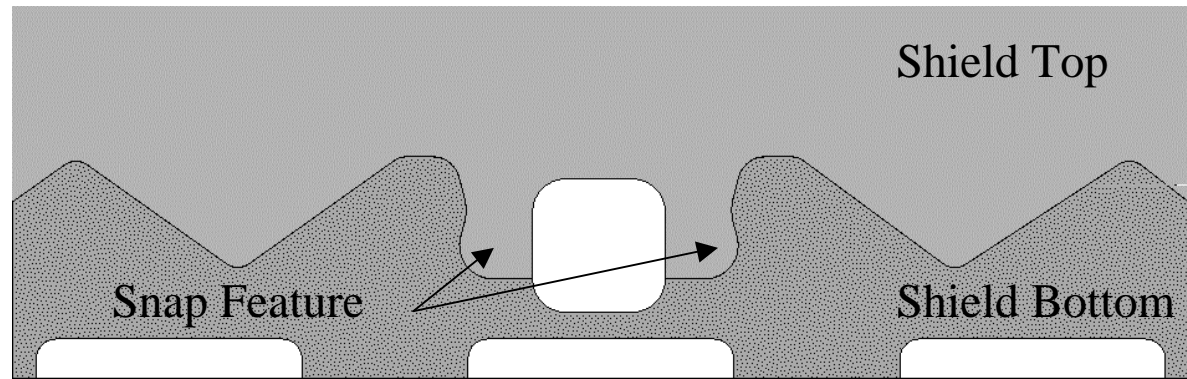

PATENT PENDING

- **Snap in feature profile may be altered but will maintain snap in or locking feature.**
- **Pattern between snap features can be varied and is necessary to prevent long length slots counterproductive to EMI suppression.**

Additional Notes

- **Key Feature is the snap in feature on side walls**
 - Created in a stamping tool process
 - Created in a manner that will allow for part to stay intact throughout manufacturing, packaging, shipping, and customer installation/solder reflow.
 - Minimum height limited to ~1.5 mm.
 - Internal walls are NOT an option.
- **Other part features may include:**
 - Partially drawn corner (Rigid Corner BLS)
 - Other Typical BLS Features
 - Ventilation Holes, Side Cutouts, Embossing, Marking, Multi-levels
- **Methods involve typical sheet metal stamping and forming operations.**



Microwave Absorber Board Level Shield



global solutions :
local support.

Microwave Absorber Board Level Shield

Laird Technologies Microwave Absorber Board Level Shields (A-BLS) are an excellent choice when your application needs shielding effectiveness at higher frequencies. These RoHS compliant shields increase a standard board level shield's effectiveness at frequencies greater than 1 GHz and up to 40 GHz (millimeter wave frequencies). The product can also be used to shield higher frequency board level components, harmonics and minimize crosstalk between components.

Microwave Absorber Board Level Shields technology utilizes a combination of Q-Zorb RFSW surface wave absorbers and board level shields.

Q-Zorb RFSW surface wave absorbers are thin, magnetically loaded elastomeric sheets designed to provide emi protection at high angles of incidence for surface wave attenuation. Board level shields provide isolation of board level components, minimizes crosstalk and susceptibility without impacting system speed. This combination product incorporates a stamped metal housing and an absorbing elastomer that is designed to meet the specific needs of your application.

For sales information:
In Asia please telephone +86 755 2714 1166
In Europe please telephone +49 8031 2460 0
In the USA please telephone +1-800-843-4556
or visit: www.lairdtech.com

Features and Benefits:

- MA-BLS enhances shielding effectiveness at frequencies from 1 – 40 GHz
- Use inside of microwave housings to reduce internal resonance and lower the "Q" of the microwave cavity
- Minimizes crosstalk and susceptibility without impacting system speed
- Effective in isolating antennas from ground plane reflections
- Compliant to EU RoHS Directive 2002/95/EC
- Custom shapes and other material options are available
- Secure cover design is ideal for applications subject to shock and vibration

Applications

- Any application requiring board level shielding
- Wireless handsets, PC cards
- High frequency communications equipment, base stations
- PDAs
- Desktop and laptop computers
- Portable and non-portable electronic devices



Engineered antenna, emi, telematics and thermal applications



Thermally Enhanced Board Level Shields



global solutions :
local support.

Thermally Enhanced Board Level Shields

Slower operating speeds, premature component failures, thermally induced stress, size limitations, and a host of other performance problems can occur when electronics components are not properly cooled.

The need to add innovative cooling techniques to electronics components is increasing as more powerful components and increased package densities are added to applications.

Air, by nature, acts as a heat insulator (only 0.03W/mK thermal conductivity) so air gaps must be removed to allow the heat to transfer from the electronics board or chip. Removing these air gaps significantly reduces the thermal load on components.

To address applications where heat needs to be removed and where board level shielding is also required, Laird Technologies is incorporating thermal interface materials with board level shields.

Adding a thermal interface gap filler material that is soft, compliant and has high thermal conductivity between the electronic component and board level shield cools the component by removing the air gap producing a more reliable electronic system.

For sales information:
In Asia please telephone +86 755 2714 1166
In Europe please telephone +49 8031 2460 0
In the USA please telephone +1-800-843-4556
or visit: www.lairdtech.com

Features and Benefits:

- Provides excellent emi shielding and thermal management in a single part assembly solution
- Uses Laird Technologies X-flex™ 600 Series thermal gap filler which is an exceptionally soft, highly compressible gap filler material with high thermal conductivity and low thermal impedance/resistance
- Provides electrical isolation of board level components
- Custom designs and shapes are available
- Other thermal interface materials are available depending upon application and specifications
- RoHS compliant

Applications

- Hand-held wireless electronic devices including PDAs and mobile phones
- Small consumer electronics products such as portable DVD players
- Notebook computers



engineered antenna, emi, telematics and thermal applications

Cool Shield II

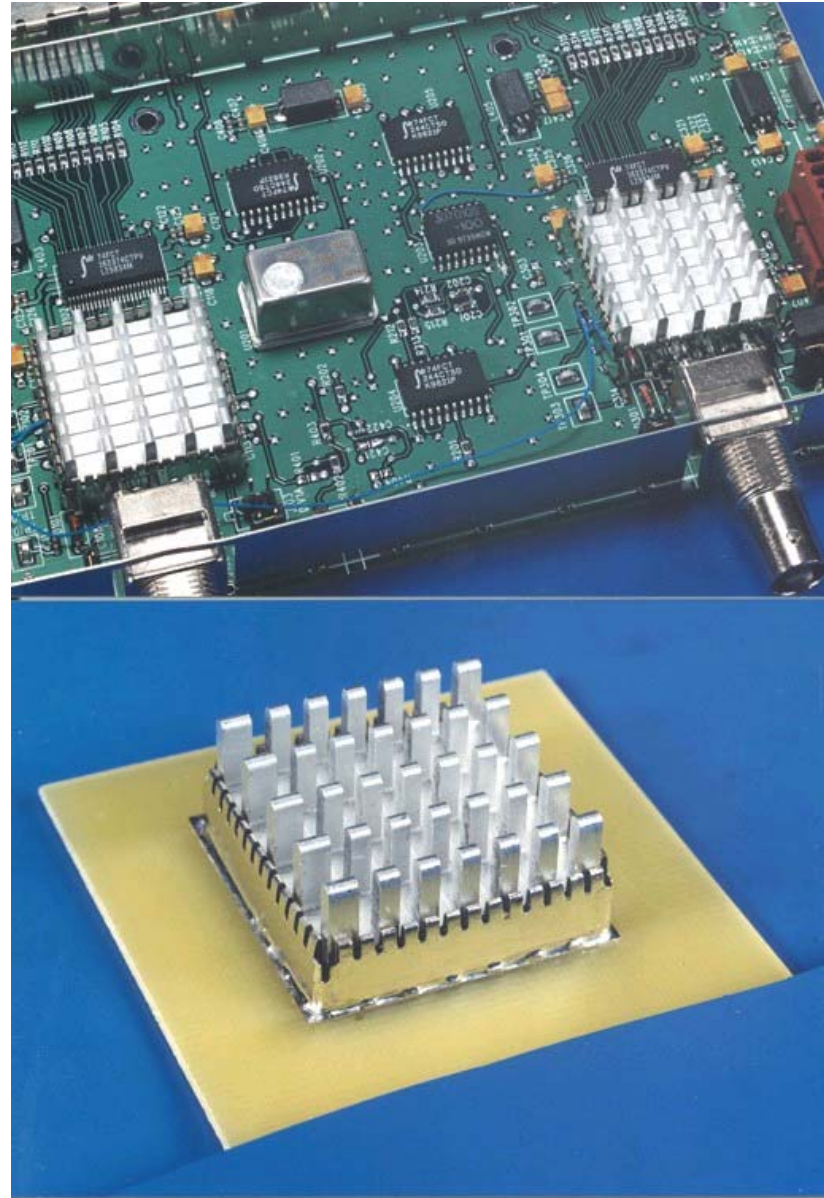

Cool Shield II

EXPLODED VIEW SCALE 3:1

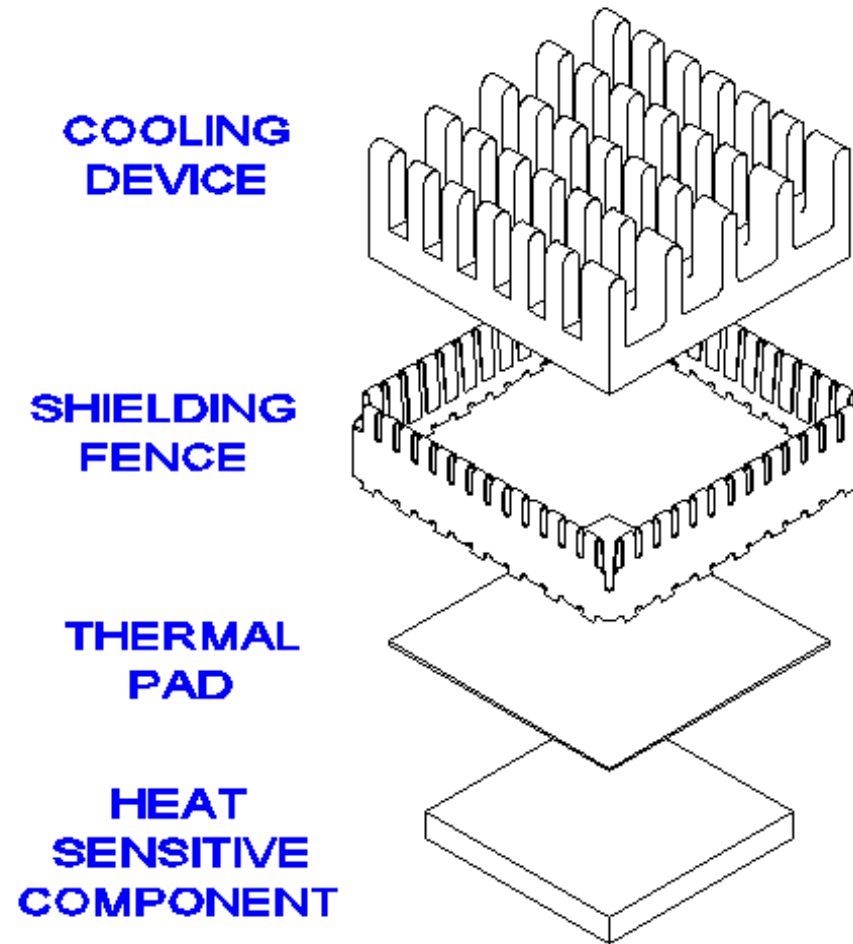

Shield for Home Automation

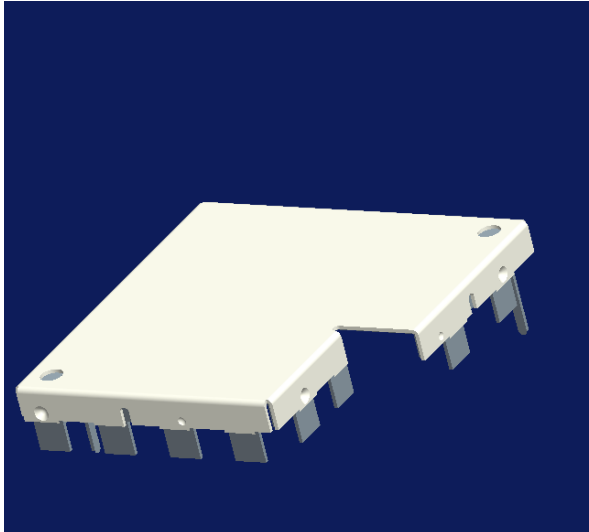

- Custom design shield with locating pins
- Frame and cover with standard contact and locking dimples

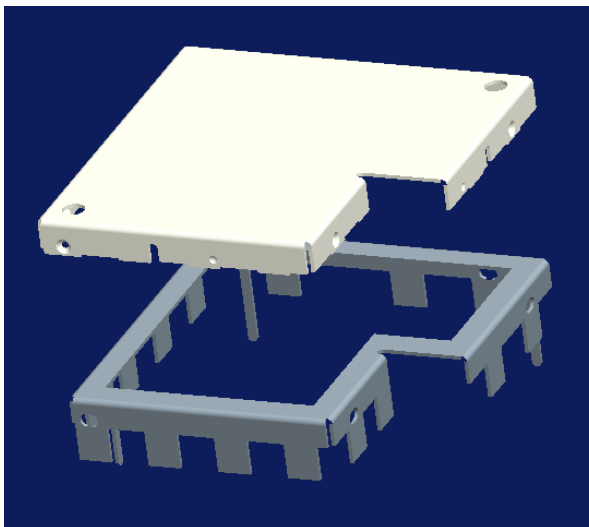

Low profile shield

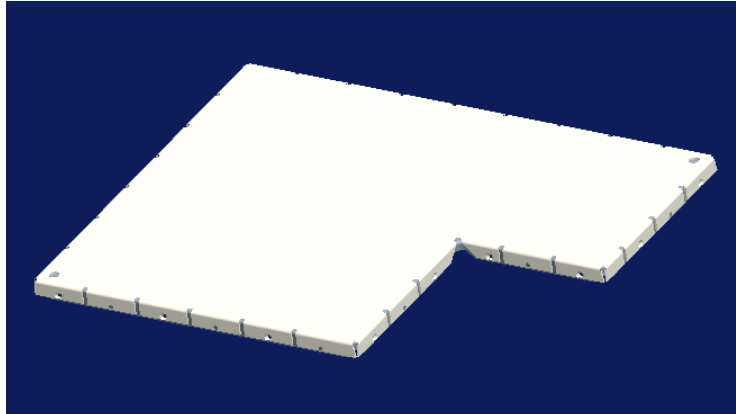

- Low height design frame of 1.65mm
- Half drawn corners for extra rigidity
- Standard contact and locking dimples

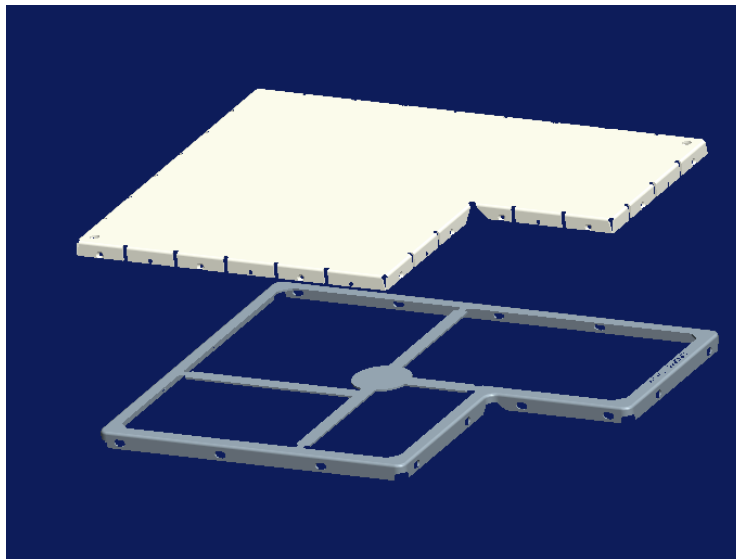

Multi compartment shield

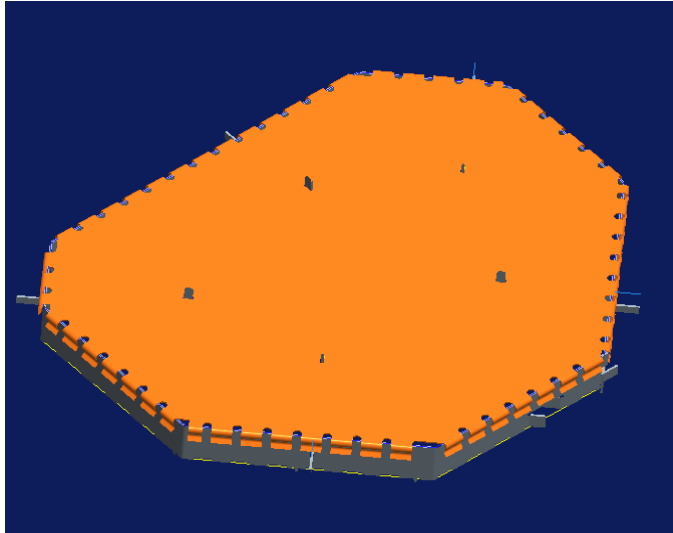

- 97-2000 Design style
- Multiple internal wall for EMI isolation
- One piece spring finger type cover

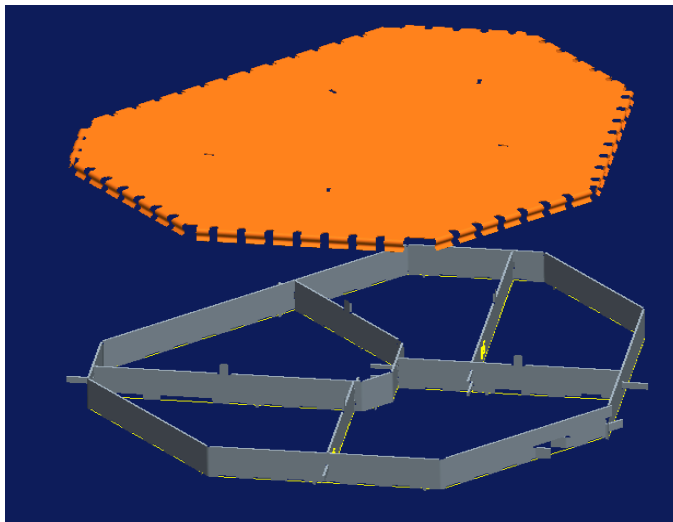

Half drawn interlocking corners

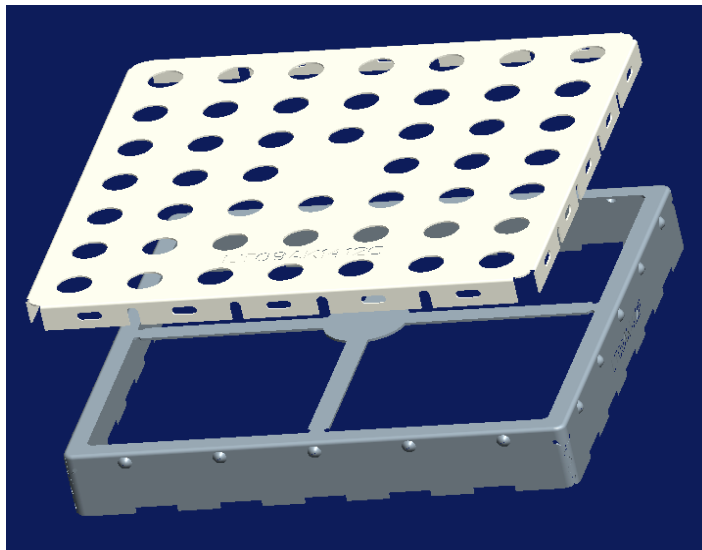
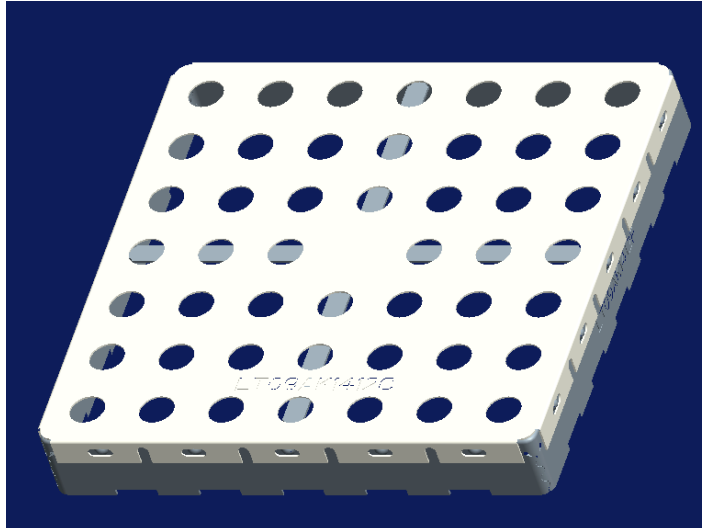

- Patented half drawn interlocking corners
- Standard locking dimples for cover retention
- Array of holes on cover for ventilation

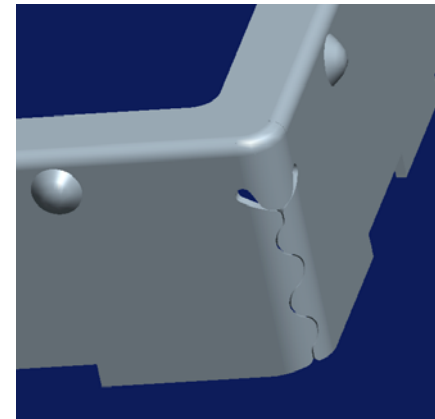

Corner Detail

One piece shield

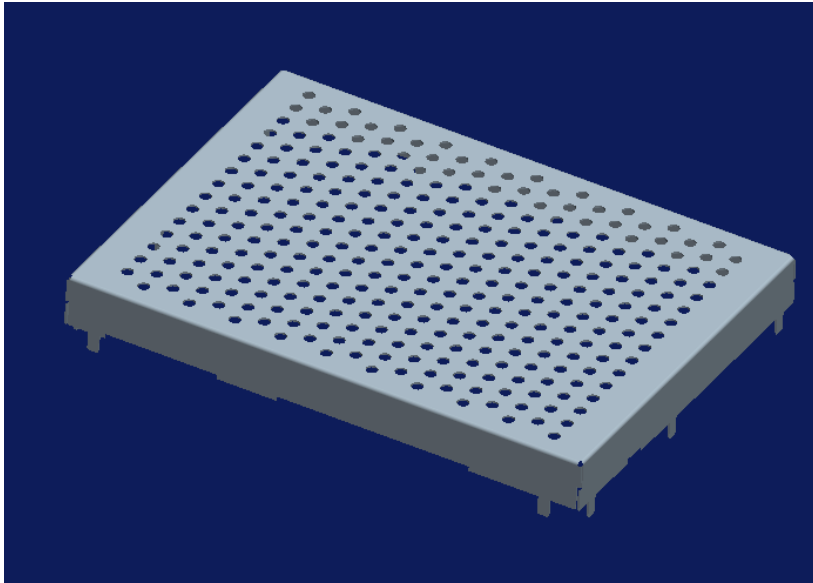

- One piece design for simplicity
- Pins for locating shield on board
- Holes for ventilation

Standard design

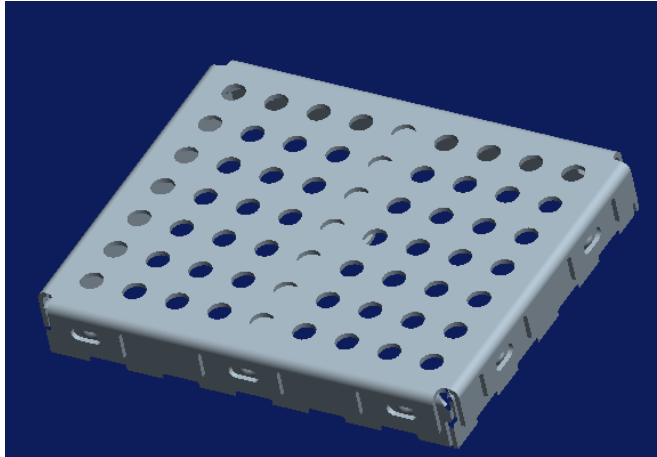

- Standard 2 piece design
- Standard interlocking corners
- Standard locking and contact dimples
- Array of holes for ventilation

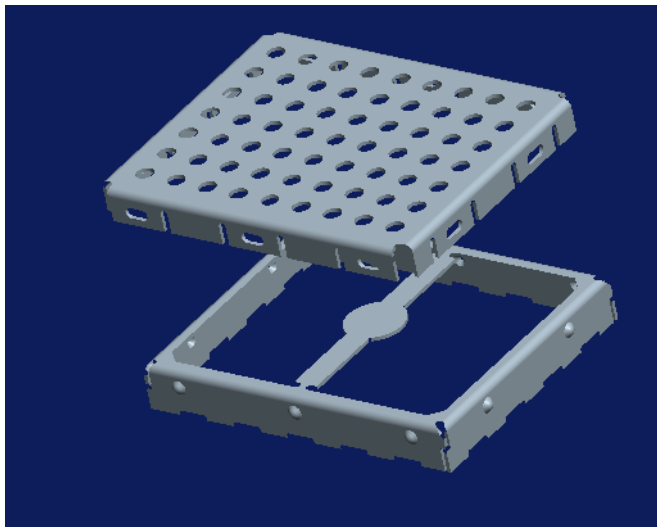

Larger standard

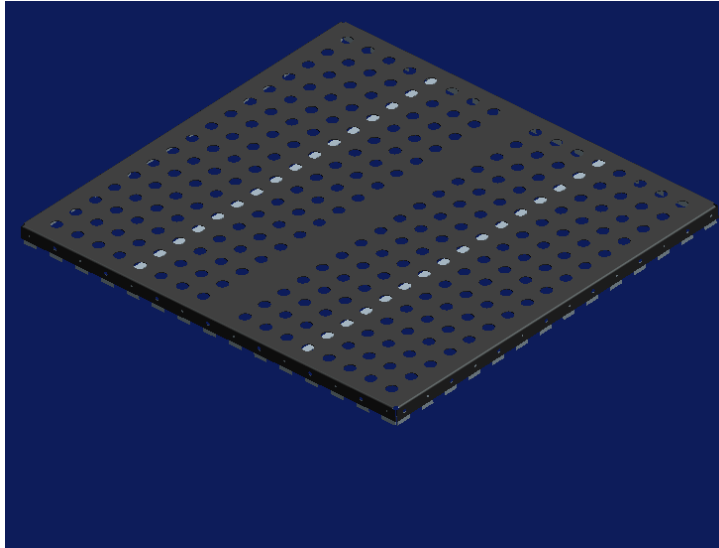

- **Standard design with contact and locking dimples**
- **Large frames require extra cross braces for addition rigidity**

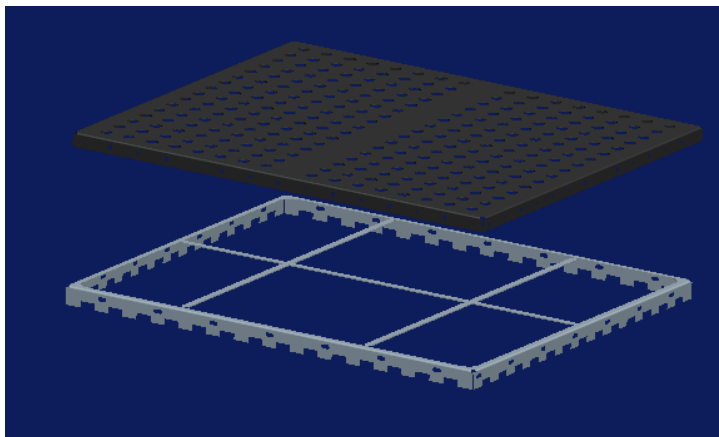

Cover with D-Snaps

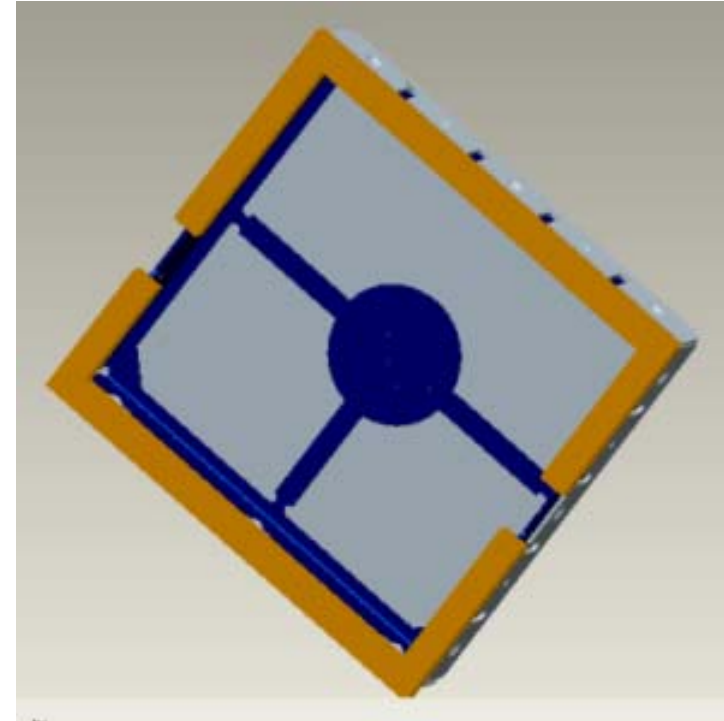
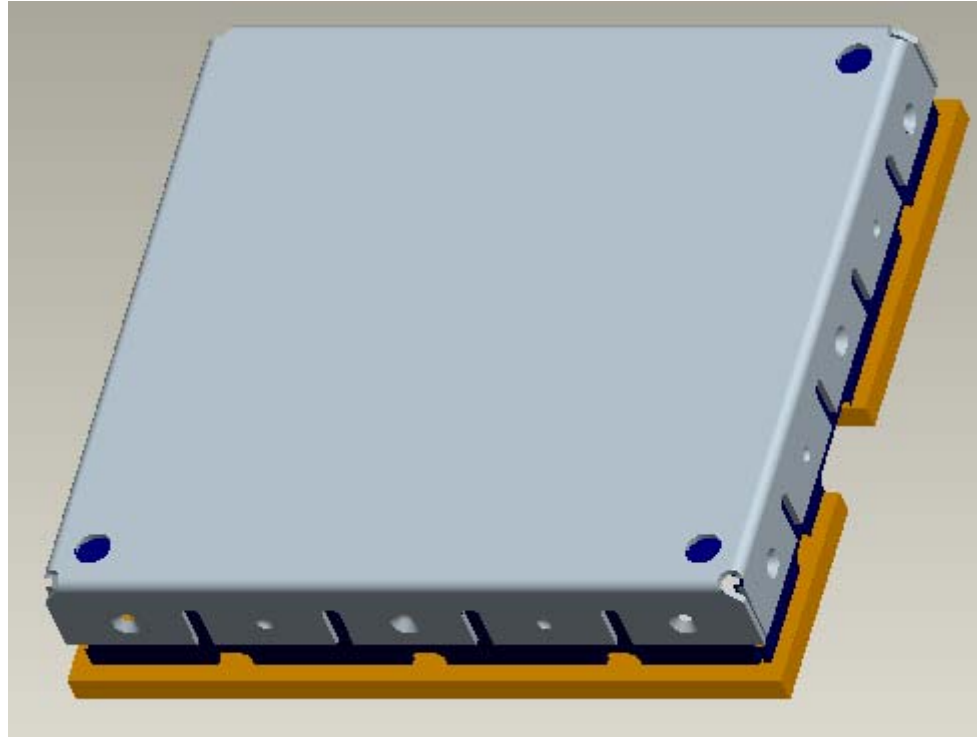

D-Snap – 2 Options

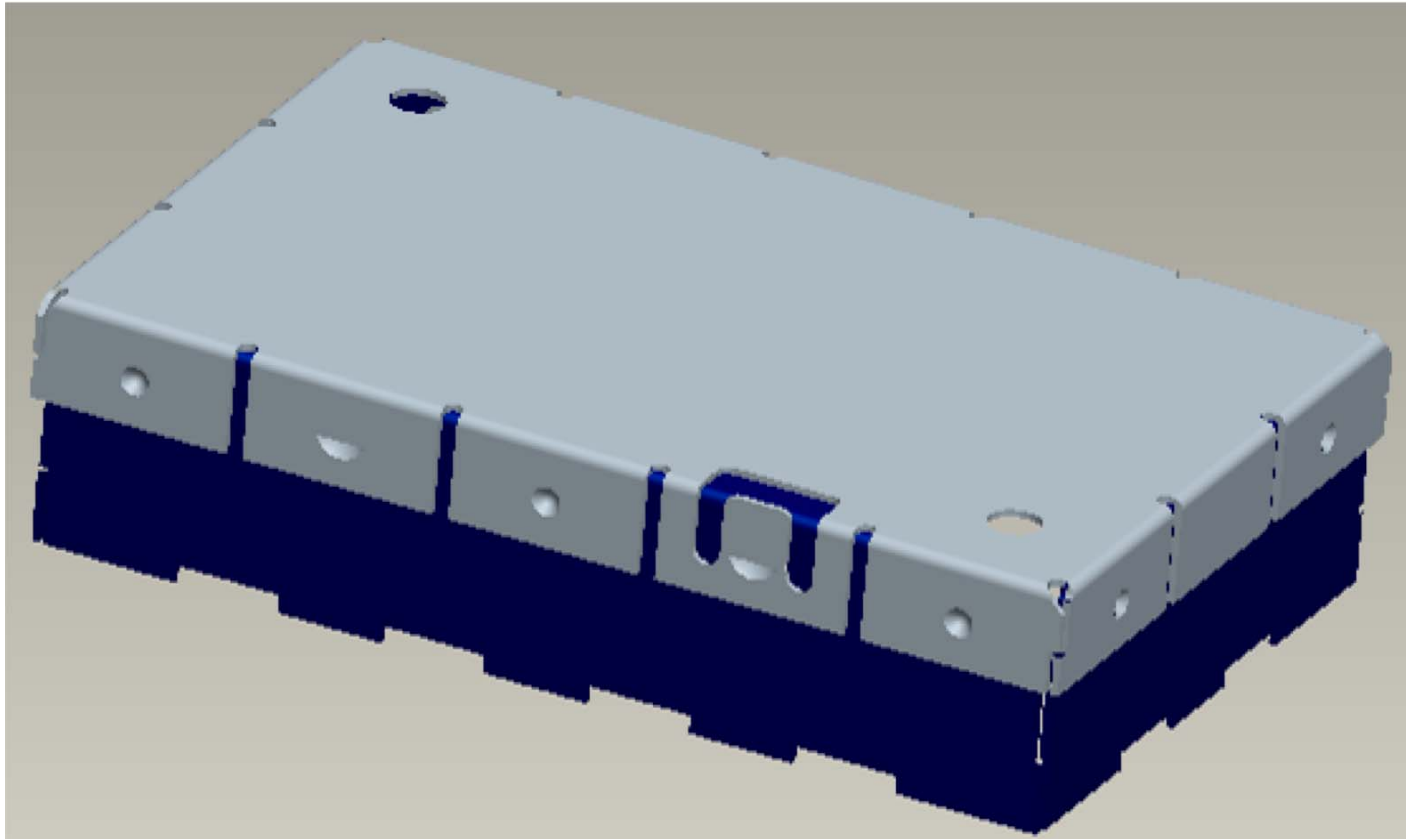

- The use of D-snaps provides options with a direction locking system.

DVB (set top box)



- **BLS used to shield Antenna input**
- **Both Cable and Satellite Set-top boxes**
- **Also used in wireless connections**



Wireless Network Systems



- Used to Shield TX / RX
- Usually large in size
- Using 900 MHz to 5 GHz



Wireless Networking



- Signal processing of Rx and Tx protected
- Shields usually surface mount, thin gauge
- 801.11 a, b, g
- WiMax



Wireless Networking

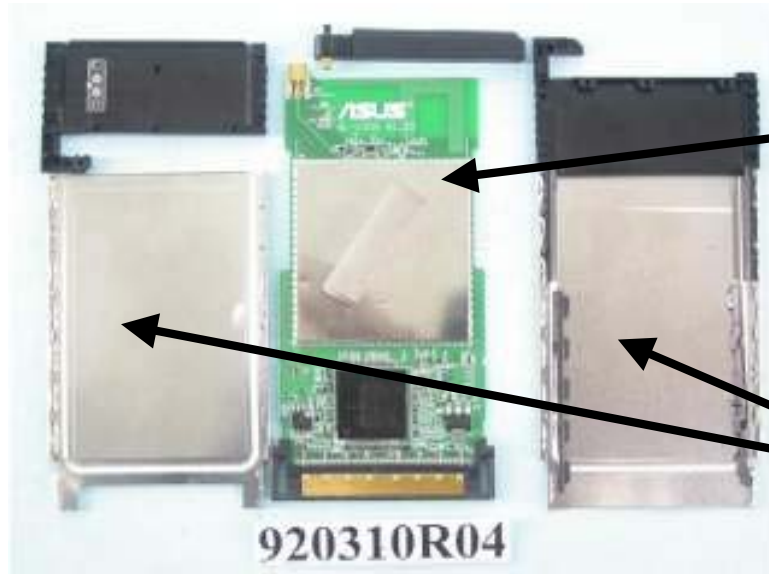

- Shielding of the processor due to small area
- Tx / Rx shielding
- Exterior case can also be used



Industrial Wireless



- Protection for the wireless protocol chipsets
- Rx / Tx

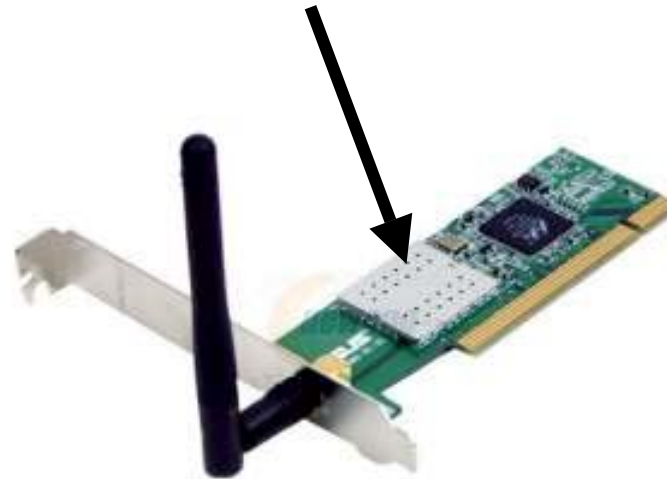

Medical Products



Protects sensitive measurement chip sets

Wireless connectivity coming

- **Can be based on broadband or wireless protocols**



Learn more at

neptunewastemanagement.com

Medical Products



Automotive

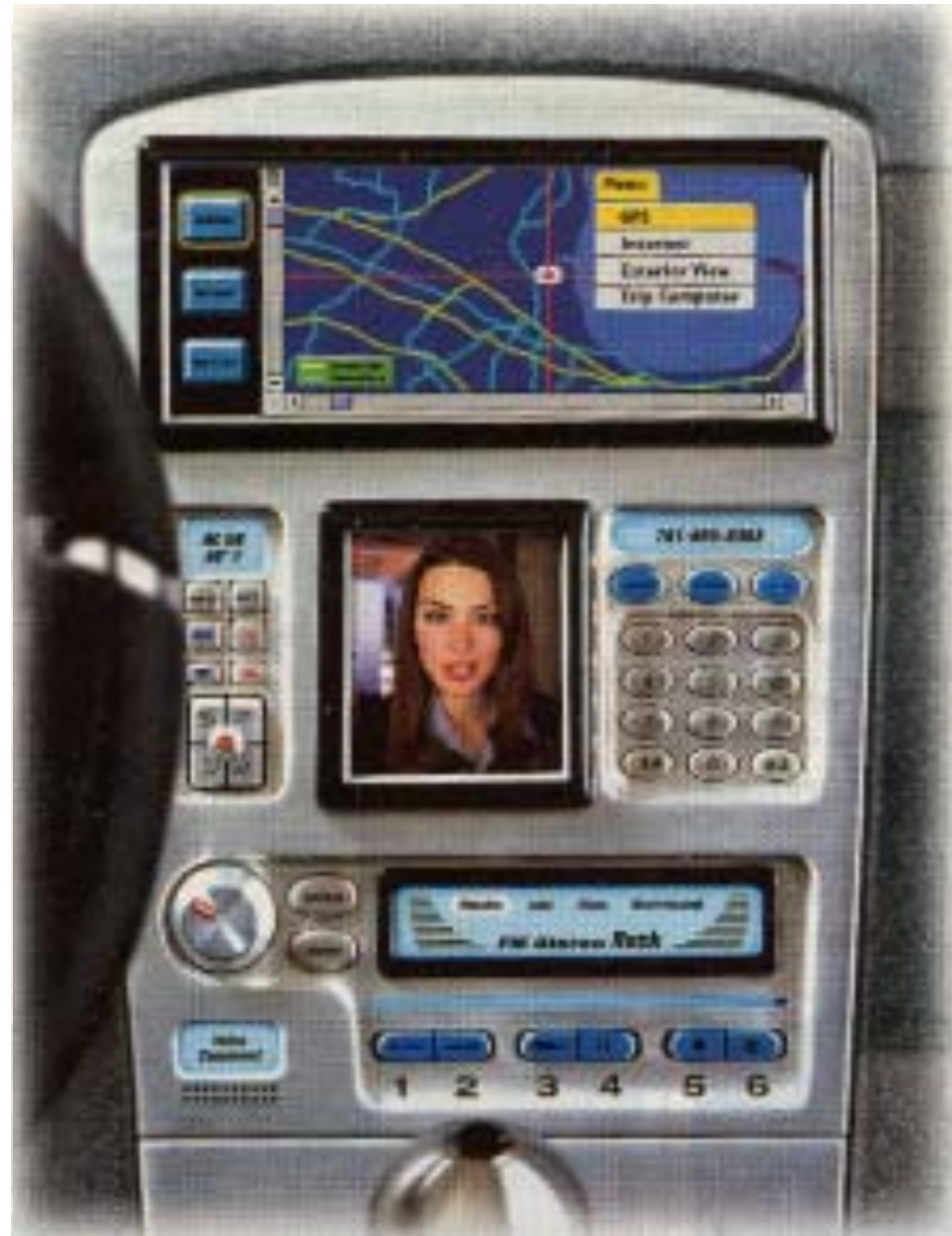

Automotive GPS Systems



GPS BOARD ASSEMBLY



Note: Laird Technologies supplies similar antenna modules (GPS patch and PCB) to GM, DOD, Ford, and European Union automotive manufacturers.

- Isolation of the GPS signal
- Protection of FM signals

Automotive – Satellite Radio

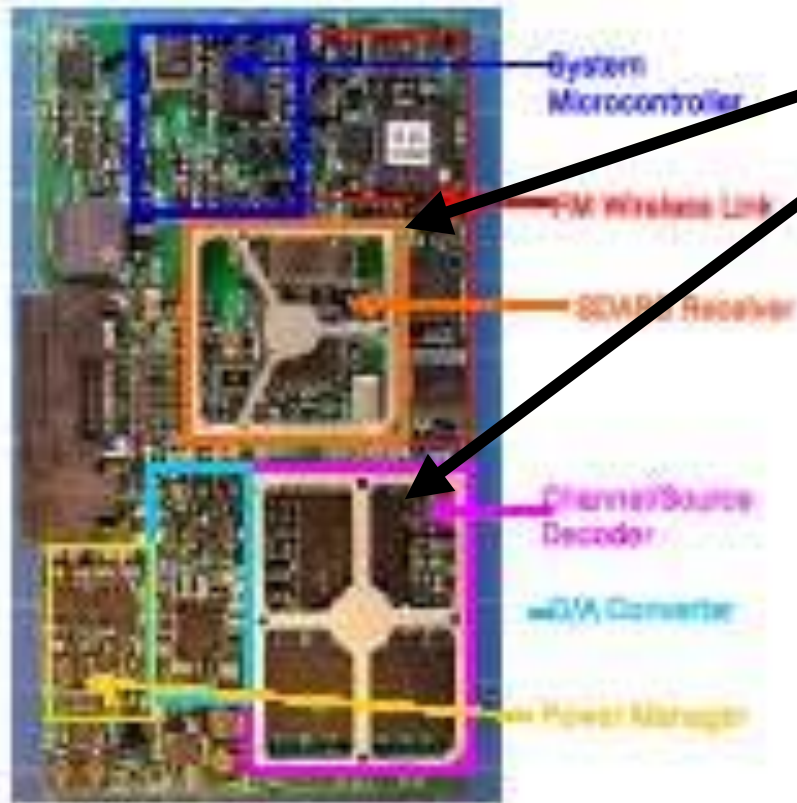

- Isolation of the FM link
- Channel / Source decoding

RF “Modules”



- RF Industry standards
- Protects the processors
- Others include IEEE 802
- IEEE 801.11

Cellular Handsets

- Board Interface contacts
- Shielding of various functions

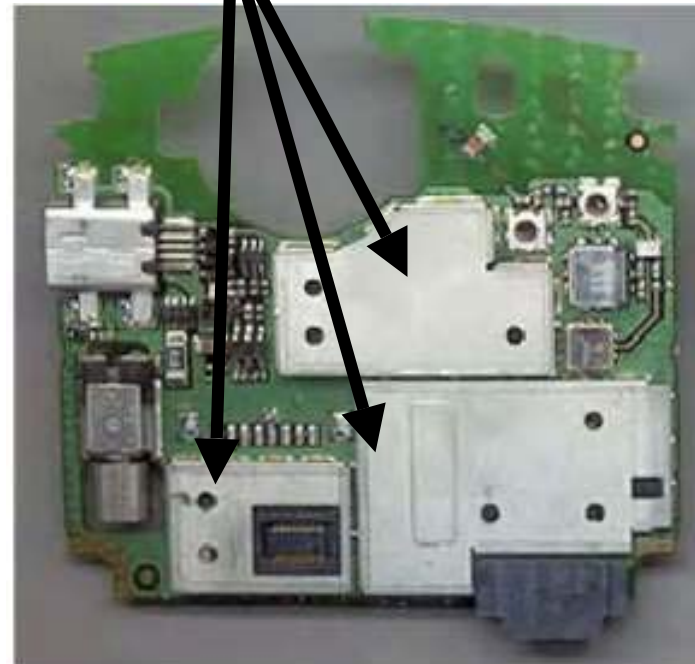
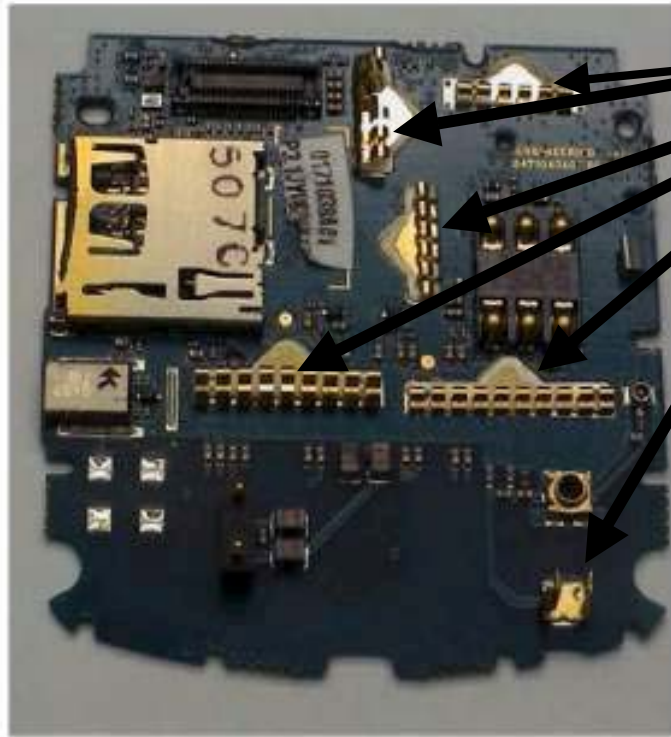

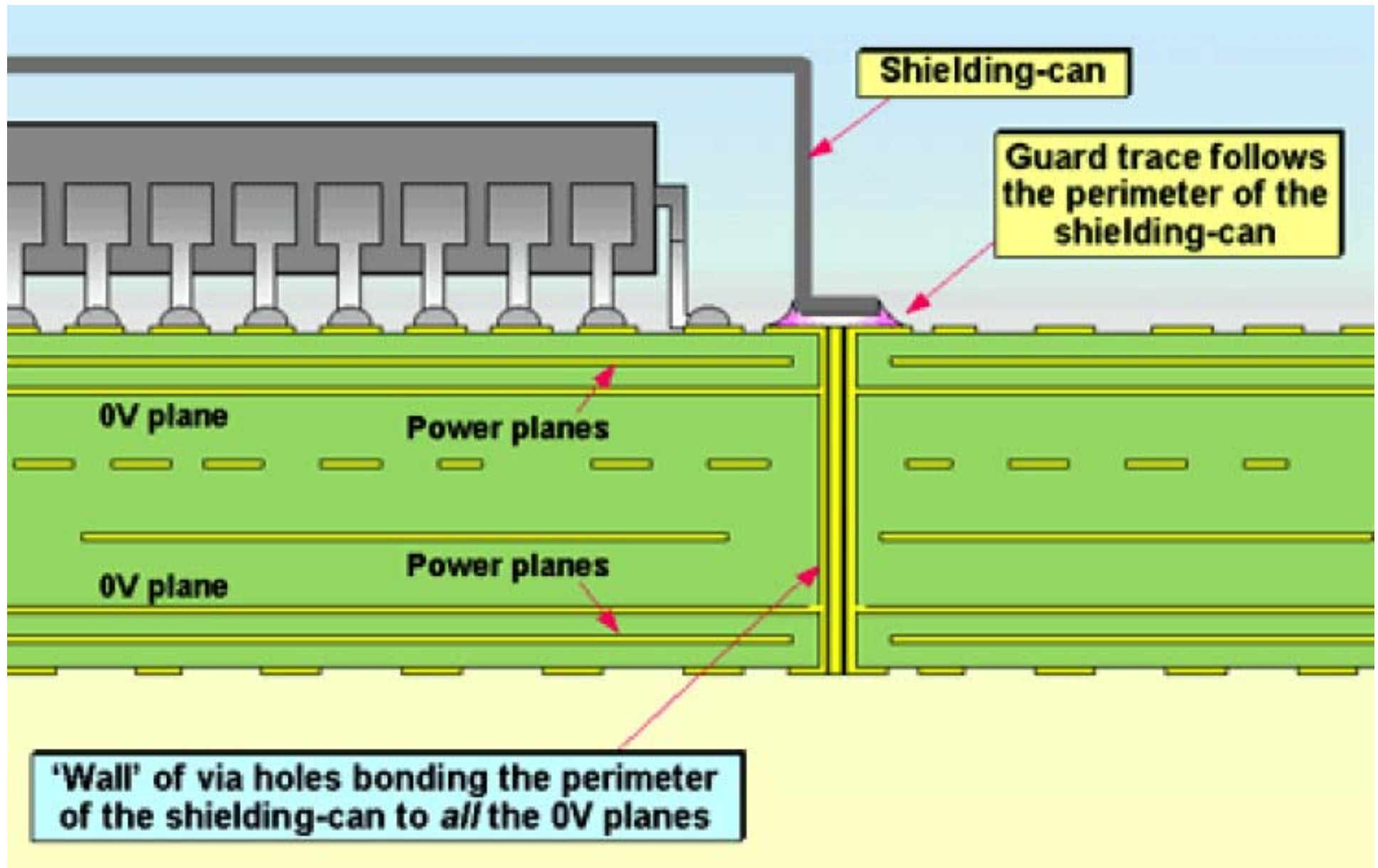

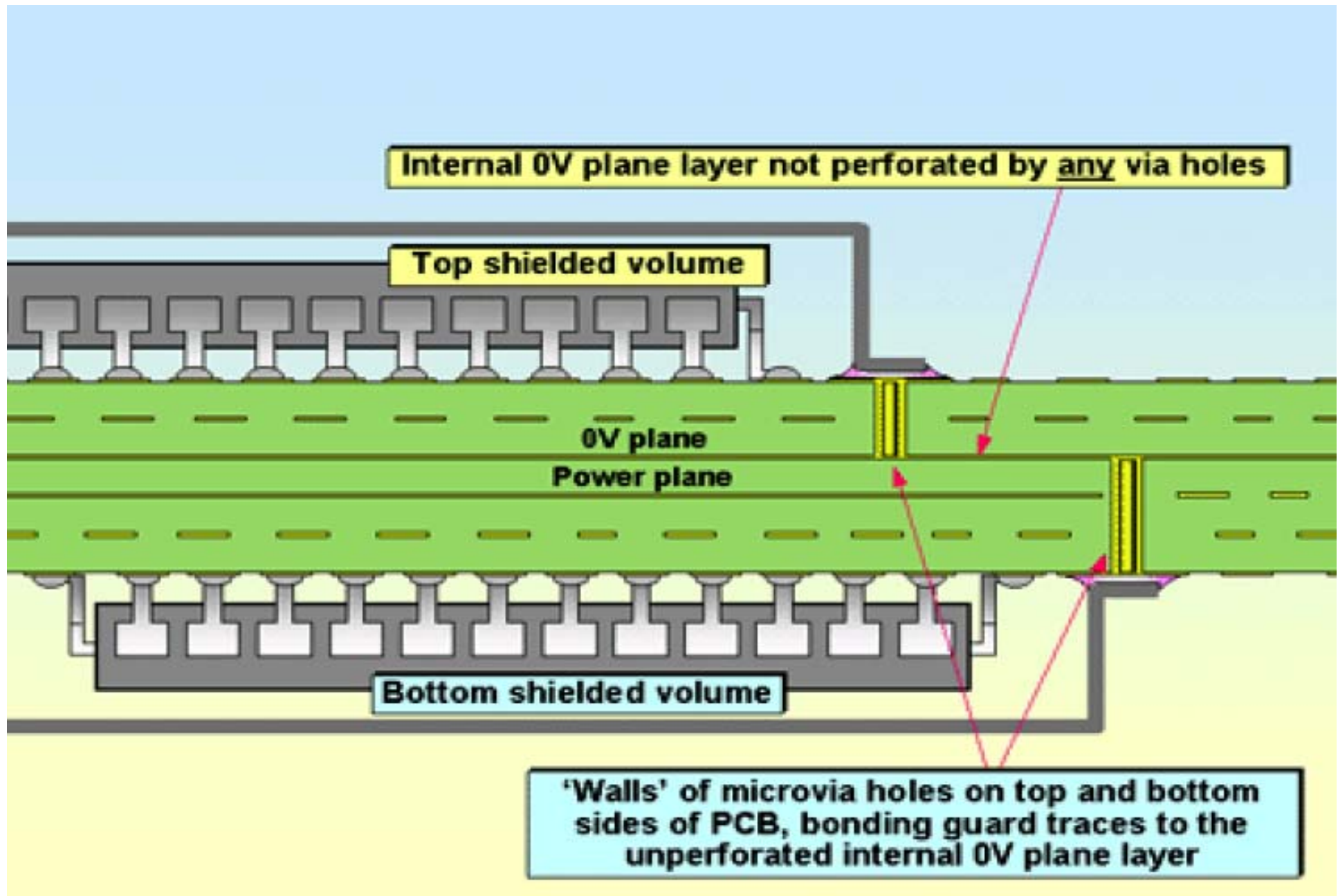

Visit our Virtual Design Center

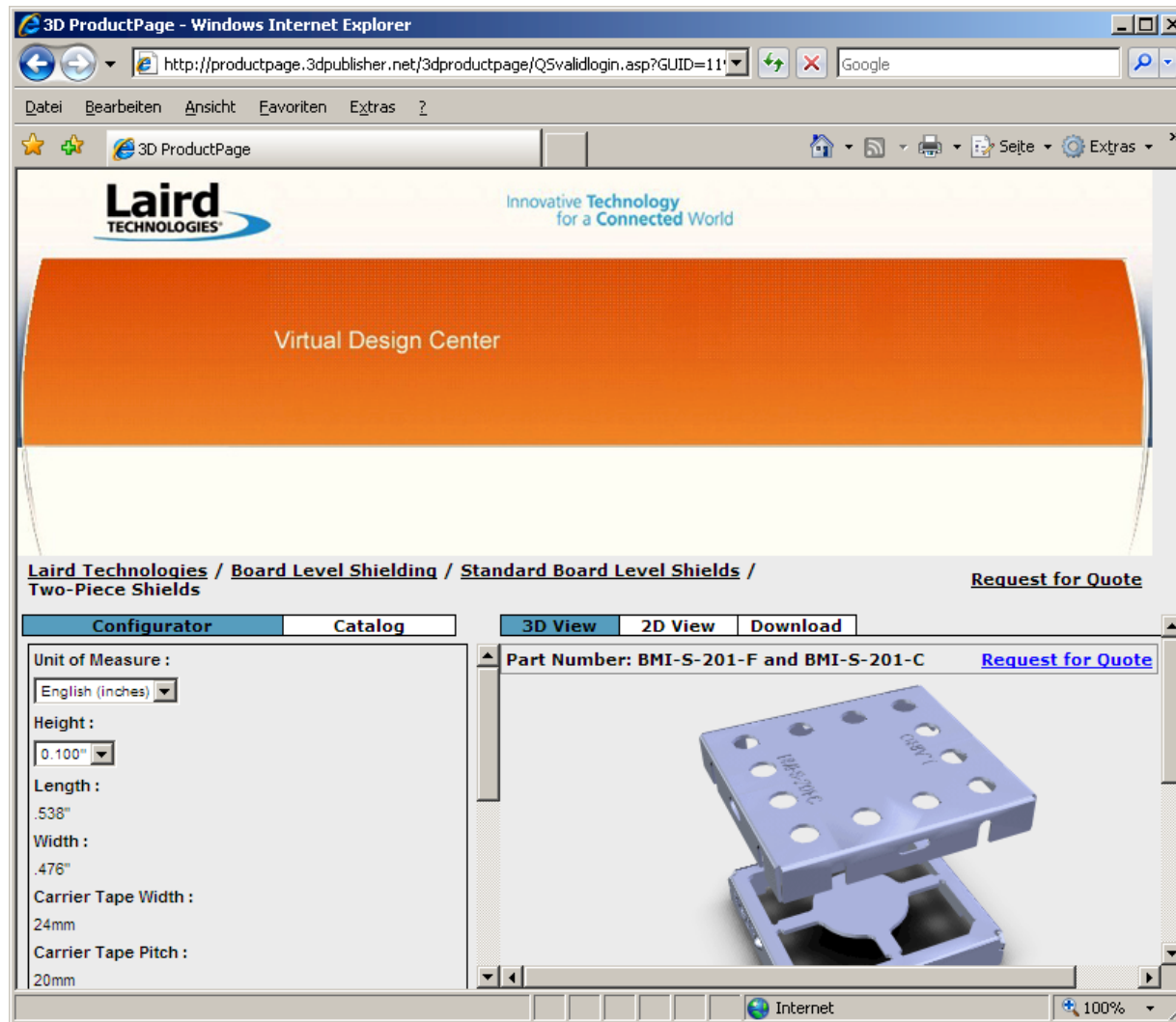



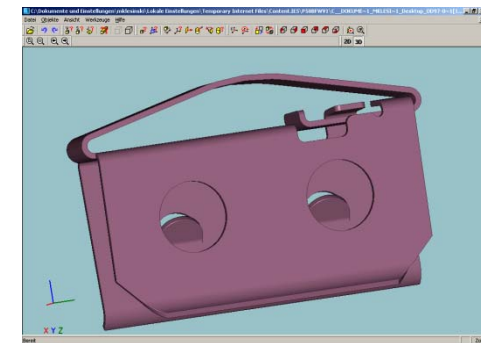



- Fingerstock & Board Level Shields
- 3D files of most of Laird standard parts are available
- Download 2D drawings
- Configure your own cut-to-length fingerstock part



New catalog available

<http://www.lairdtech.com/WorkArea/linkit.aspx?LinkIdentifier=id&ItemID=3282>

BOARD LEVEL SHIELDS PRODUCT SELECTION GUIDE

BLS Design Type / Features	Key Attributes & Application Consideration	Corner Feature			
		Traditional Folded	Rigid Corner	Full Drawn w/ Flange	Full Drawn Zero Flange
					
			Improves Flatness by increasing torsional rigidity	Most mechanically rigid, but depth attainable is material and configuration dependent	Similar to Full Drawn, Tooling more complex.
SINGLE PIECE					
Single Piece	 Simple low cost BLS Solution	Opt	Std	Opt (height/mat'l limits)	Opt
TWO PIECE					
Traditional	 Post Reflow Component Access for Inspect, test, cleaning, etc. Various cover retention features available to address rattling, EMI, and shock/vibration concerns. Optional pre-assembled deliverable				
Frame		Opt	Std	Opt (height/mat'l limits)	Low Height Option
Cover		Std	Opt	Opt (height/mat'l limits)	N/A
ReCovr	 Lower total cost 2 piece solution. Eaveless side wall for maximum component access.	N/A	Req'd	N/A	N/A



Innovative **Technology**
for a **Connected** World

MERCI
THANK YOU

global solutions: local support™